



# **Sorensen**

## **SGA Series DC Power Supplies**

*Operation Manual*







## **About AMETEK**

AMETEK Programmable Power, Inc., a Division of AMETEK, Inc., is a global leader in the design and manufacture of precision, programmable power supplies for R&D, test and measurement, process control, power bus simulation and power conditioning applications across diverse industrial segments. From bench top supplies to rack-mounted industrial power subsystems, AMETEK Programmable Power is the proud manufacturer of Elgar, Sorensen, California Instruments and Power Ten brand power supplies.

AMETEK, Inc. is a leading global manufacturer of electronic instruments and electromechanical devices with annualized sales of \$2.5 billion. The Company has over 11,000 colleagues working at more than 80 manufacturing facilities and more than 80 sales and service centers in the United States and around the world.

## **Trademarks**

AMETEK is a registered trademark of AMETEK, Inc.

Other trademarks, registered trademarks, and product names are the property of their respective owners and are used herein for identification purposes only.

## **Notice of Copyright**

*SGA Series DC Power Supplies Operation Manual* © 2010-2011 AMETEK Programmable Power, Inc. All rights reserved.

## **Exclusion for Documentation**

UNLESS SPECIFICALLY AGREED TO IN WRITING, AMETEK PROGRAMMABLE POWER, INC. ("AMETEK"):

- (a) MAKES NO WARRANTY AS TO THE ACCURACY, SUFFICIENCY OR SUITABILITY OF ANY TECHNICAL OR OTHER INFORMATION PROVIDED IN ITS MANUALS OR OTHER DOCUMENTATION.
- (b) ASSUMES NO RESPONSIBILITY OR LIABILITY FOR LOSSES, DAMAGES, COSTS OR EXPENSES, WHETHER SPECIAL, DIRECT, INDIRECT, CONSEQUENTIAL OR INCIDENTAL, WHICH MIGHT ARISE OUT OF THE USE OF SUCH INFORMATION. THE USE OF ANY SUCH INFORMATION WILL BE ENTIRELY AT THE USER'S RISK, AND
- (c) REMINDS YOU THAT IF THIS MANUAL IS IN ANY LANGUAGE OTHER THAN ENGLISH, ALTHOUGH STEPS HAVE BEEN TAKEN TO MAINTAIN THE ACCURACY OF THE TRANSLATION, THE ACCURACY CANNOT BE GUARANTEED. APPROVED AMETEK CONTENT IS CONTAINED WITH THE ENGLISH LANGUAGE VERSION, WHICH IS POSTED AT [WWW.PROGRAMMABLEPOWER.COM](http://WWW.PROGRAMMABLEPOWER.COM).

## **Date and Revision**

January 2011 Revision W

## **Part Number**

M550129-01

## **Contact Information**



Telephone: 800 733 5427 (toll free in North America)  
858 450 0085 (direct)  
Fax: 858 458 0267  
Email: [sales@programmablepower.com](mailto:sales@programmablepower.com)  
[service@programmablepower.com](mailto:service@programmablepower.com)  
Web: [www.programmablepower.com](http://www.programmablepower.com)

This page intentionally left blank.

# IMPORTANT SAFETY INSTRUCTIONS

---

Before applying power to the system, verify that your product is configured properly for your particular application.

 <b>WARNING</b>	Hazardous voltages may be present when covers are removed. Qualified personnel must use extreme caution when servicing this equipment. Circuit boards, test points, and output voltages also may be floating above (below) chassis ground.
 <b>WARNING</b>	The equipment used contains ESD sensitive ports. When installing equipment, follow ESD Safety Procedures. Electrostatic discharges might cause damage to the equipment.

Only *qualified personnel* who deal with attendant hazards in power supplies, are allowed to perform installation and servicing.

Ensure that the AC power line ground is connected properly to the Power Rack input connector or chassis. Similarly, other power ground lines including those to application and maintenance equipment *must* be grounded properly for both personnel and equipment safety.

Always ensure that facility AC input power is de-energized prior to connecting or disconnecting any cable.

In normal operation, the operator does not have access to hazardous voltages within the chassis. However, depending on the user's application configuration, **HIGH VOLTAGES HAZARDOUS TO HUMAN SAFETY** may be normally generated on the output terminals. The customer/user must ensure that the output power lines are labeled properly as to the safety hazards and that any inadvertent contact with hazardous voltages is eliminated.

Guard against risks of electrical shock during open cover checks by not touching any portion of the electrical circuits. Even when power is off, capacitors may retain an electrical charge. Use safety glasses during open cover checks to avoid personal injury by any sudden component failure.

Neither AMETEK Programmable Power Inc., San Diego, California, USA, nor any of the subsidiary sales organizations can accept any responsibility for personnel, material or inconsequential injury, loss or damage that results from improper use of the equipment and accessories.

## SAFETY SYMBOLS



**WARNING:** Electrical Shock Hazard



**HAZARD:** Strong oxidizer



**GENERAL WARNING/CAUTION:** Read the accompanying message for specific information.



**BURN HAZARD:** Hot Surface Warning. Allow to cool before servicing.



**Do Not Touch:** Touching some parts of the instrument without protection or proper tools could result in damage to the part(s) and/or the instrument.



**Technician Symbol:** All operations marked with this symbol are to be performed by qualified maintenance personnel only.



**Electrical Ground:** This symbol inside the instrument marks the central safety grounding point for the instrument.

This page intentionally left blank.

## Product Family: SGA Series DC Power Supplies

**Warranty Period:** Error! Unknown document property name.

### WARRANTY TERMS

AMETEK Programmable Power, Inc. (“AMETEK”), provides this written warranty covering the Product stated above, and if the Buyer discovers and notifies AMETEK in writing of any defect in material or workmanship within the applicable warranty period stated above, then AMETEK may, at its option: repair or replace the Product; or issue a credit note for the defective Product; or provide the Buyer with replacement parts for the Product.

The Buyer will, at its expense, return the defective Product or parts thereof to AMETEK in accordance with the return procedure specified below. AMETEK will, at its expense, deliver the repaired or replaced Product or parts to the Buyer. Any warranty of AMETEK will not apply if the Buyer is in default under the Purchase Order Agreement or where the Product or any part thereof:

- is damaged by misuse, accident, negligence or failure to maintain the same as specified or required by AMETEK;
- is damaged by modifications, alterations or attachments thereto which are not authorized by AMETEK;
- is installed or operated contrary to the instructions of AMETEK;
- is opened, modified or disassembled in any way without AMETEK’s consent; or
- is used in combination with items, articles or materials not authorized by AMETEK.

The Buyer may not assert any claim that the Products are not in conformity with any warranty until the Buyer has made all payments to AMETEK provided for in the Purchase Order Agreement.

### PRODUCT RETURN PROCEDURE

Request a Return Material Authorization (RMA) number from the repair facility (**must be done in the country in which it was purchased**):

- **In the USA**, contact the AMETEK Repair Department prior to the return of the product to AMETEK for repair:  
Telephone: 800-733-5427, ext. 2295 or ext. 2463 (toll free North America)  
858-450-0085, ext. 2295 or ext. 2463 (direct)
- Outside **the United States**, contact the nearest Authorized Service Center (ASC). A full listing can be found either through your local distributor or our website, [www.programmablepower.com](http://www.programmablepower.com), by clicking Support and going to the Service Centers tab.

When requesting an RMA, have the following information ready:

- Model number
- Serial number
- Description of the problem

**NOTE:** Unauthorized returns will not be accepted and will be returned at the shipper’s expense.

**NOTE:** A returned product found upon inspection by AMETEK, to be in specification is subject to an evaluation fee and applicable freight charges.

This page intentionally left blank.

## **FCC NOTICE**

---

This equipment has been tested and found to comply with the limits for a Class A digital device, pursuant to part 15 of the FCC Rules. These limits are designed to provide reasonable protection against harmful interference when the equipment is operated in a commercial environment.

This equipment generates, uses, and can radiate radio frequency energy and, if not installed and used in accordance with the instruction manual, may cause harmful interference to radio communications. Operation of this equipment in a residential area is likely to cause harmful interference in which case the user will be required to correct the interference at his own expense.

## ABOUT THIS MANUAL

---

This manual has been written expressly for the Sorensen SGA Series of power supplies that have been designed and certified to meet the Low Voltage and Electromagnetic Compatibility Directive Requirements of the European Community.

These models have been designed and tested to meet the Electromagnetic Compatibility directive (European Council directive 2004/108/EC; generally referred to as the EMC directive) and to the requirements of the Low Voltage directive (European Council directive 2006/95/EC, 93/68/EEC, dated 22 July 1993). In addition these models have been found compliant with FCC 47 CFR Part 15, Subpart B 107(e) Class A, 109(g) Class A.

Since the Low Voltage Directive is to ensure the safety of the equipment operator, universal graphic symbols have been used both on the unit itself and in this manual to warn the operator of potentially hazardous situations (see Safety Notice page).

# CONTENTS

SECTION 1 OVERVIEW .....	1-1
1.1 General Description .....	1-1
1.2 Specifications .....	1-2
1.2.1 Environmental Characteristics .....	1-2
1.2.2 Electrical Characteristics .....	1-2
1.2.3 SGA Series Voltage and Current Specifications .....	1-4
1.2.4 Physical Characteristics .....	1-5
INSTALLATION .....	1-1
2.1 Inspection .....	1-1
2.2 Contents of Shipment .....	1-1
2.3 Location and Mounting .....	1-2
2.3.1 Rack .....	1-3
2.3.2 6U Chassis Removal from Rack .....	1-3
2.4 Input/Output Connections .....	1-3
2.5 Wire selection .....	1-6
2.5.1 Wire Size .....	1-6
2.6 Load Considerations .....	1-9
2.6.1 Inductive Loads .....	1-9
2.7 Outline Drawings .....	1-9
2.8 Installation Drawings .....	1-13
OPERATION .....	3-1
3.1 Introduction .....	3-1
3.2 Controls and Indicators .....	3-1
3.2.1 Front Panel .....	3-1
3.2.2 Shaft Lock (Option) .....	3-8
3.3 Local Operation .....	3-9

3.3.1	Floating and Polarized Output.....	3-9
3.3.2	Initial Setup.....	3-10
3.3.3	Voltage Mode Operation .....	3-10
3.3.4	Current Mode Operation.....	3-11
3.3.5	Overvoltage Protection.....	3-12
3.3.6	Analog Control Connector (J1).....	3-13
3.4	Remote Current Programming .....	3-17
3.4.1	Remote Current Programming Using Resistance:.....	3-17
3.4.2	Remote Current Programming Using a 0-5 or 0-10 VDC Voltage Source.....	3-18
3.5	Remote Voltage Programming .....	3-19
3.5.1	External Voltage Programming Using Resistance .....	3-19
3.5.2	External Voltage Programming Using a 0-5 or 0-10 VDC Voltage Source.....	3-20
3.6	Remote Sensing.....	3-21
3.7	Remote Output ON/OFF Control.....	3-23
3.7.1	Remote Output ON/OFF by Contact Closure.....	3-23
3.7.2	Remote Output ON/OFF Control by an External 12 to 240 VAC or 6 to 120 VDC or TTL/CMOS Source.....	3-23
3.8	Remote Overvoltage Setpoint .....	3-24
3.9	Remote Shutdown (S/D) .....	3-25
3.10	Parallel and Series Operation .....	3-26
3.10.1	Parallel Operation.....	3-26
3.10.2	Series Operation .....	3-27

## MAINTENANCE ..... 4-1

4.1	Introduction.....	4-1
4.2	Preventive Maintenance.....	4-1
4.3	Fuses.....	4-3

## LIST OF TABLES

Table 2–1.	5kW to 15kW and 20kW to 30kW Series Input/Output Connectors.....	1-4
Table 2–2.	Input Connections .....	1-4
Table 2–3.	Output Connections .....	1-5
Table 2–4.	Minimum Wire Size .....	1-6
Table 2–5.	Wire Resistance and Voltage Drop.....	1-7
Table 2–6.	Maximum AC Current Ratings .....	1-8
Table 2–7.	Recommended Lugs.....	1-8
Table 2–8.	Recommended Sense Connector Tools.....	1-8
Table 3–1.	ANALOG CONTROL Connector (J1), Designations and Functions .....	3-16
Table 4–1.	Recommended Annual Inspection.....	4-2

## LIST OF FIGURES

Figure 1-1. Model Number Decoding .....	1-1
Figure 2-1. Diode Connection.....	1-9
Figure 2-2. SGA Dimensions, 3U Model, 5kW to 15kW (40V-800V).....	1-10
Figure 2-3. SGA Dimensions, 3U Model, 4kW to 15kW (10V-30V).....	1-11
Figure 2-4. SGA Dimensions, 6U Models, 20kW to 30kW .....	1-12
Figure 2-5. Rear Panel Input-Output Connector Locations, Models 40V-600V.....	1-13
Figure 2-6. Rear Panel Input-Output Connector Locations, Models 10V-30V.....	1-14
Figure 2-7. 800V Rear Panel Input-Output Connector Locations.....	1-15
Figure 2-8. SGA Detailed Chassis Dimensions for Installation, Models 40V-600V ....	1-16
Figure 2-9. SGA Detailed Chassis Dimensions for Installation, Models 10V-30V.....	1-17
Figure 2-10 SGA 800V Detailed Chassis Dimensions for Installation .....	1-18
Figure 2-11. Instructions for Assembly of AC and DC Covers .....	1-19
Figure 3-1. SGA Front Panel Controls and Indicators (3U model shown).....	3-1
Figure 3-2. SG Rear Panel with GPIB Option (40V-800V) .....	3-3
Figure 3-3. SG Rear Panel with GPIB Option (10V-300V) .....	3-3
Figure 3-4. SG Rear Panel with Ethernet Option (40V-800V) .....	3-5
Figure 3-5. SG Rear Panel with Ethernet Option (10V-30V) .....	3-5
Figure 3-6. SGA 6U Rear Panel with GPIB/RS232 Option Connectors .....	3-7
Figure 3-7. Shaft Lock .....	3-8
Figure 3-8. ANALOG CONTROL Connector (J1) Pin-out .....	3-13
Figure 3-9. Remote Current Programming Using Resistance .....	3-17
Figure 3-10. Remote Current Programming Using 0-5 or 0-10 VDC Voltage Source	3-18
Figure 3-11. Remote Voltage Programming Using Resistance.....	3-19
Figure 3-12. Remote Voltage Programming Using 0-5 or 0-10 VDC Voltage Source	3-20
Figure 3-13. Local/Remote Voltage Sensing.....	3-21
Figure 3-14. Remote Sensing Operation at the Load.....	3-22
Figure 3-15. Remote Output ON/OFF Control by Contact Closure .....	3-23
Figure 3-16. Remote Output ON/OFF Using Isolated AC or DC Voltage Source .....	3-23
Figure 3-17. Remote Output ON/OFF Using Isolated TTL/CMOS Voltage Supply ....	3-24
Figure 3-18. Remote Overvoltage Set Using DC Voltage Source.....	3-24
Figure 3-19. Remote Shutdown Using DC Voltage Source.....	3-25
Figure 3-20. Parallel and Remote/Local Sense Connections.....	3-27

This page intentionally left blank.

# SECTION 1 OVERVIEW

## 1.1 GENERAL DESCRIPTION

The Sorensen SGA Series power supplies are general-purpose power supplies designed specifically for laboratory test and systems applications requiring variable DC sources with good ripple and regulation characteristics. These power supplies are constant current/constant voltage supplies with an automatic crossover feature.

A variety of user interfaces are available, ranging from manual front-panel control and standard non-isolated remote analog control, to optional GPIB, Ethernet or isolated remote analog control.

Figure 1-1 decodes the SG Series model number.

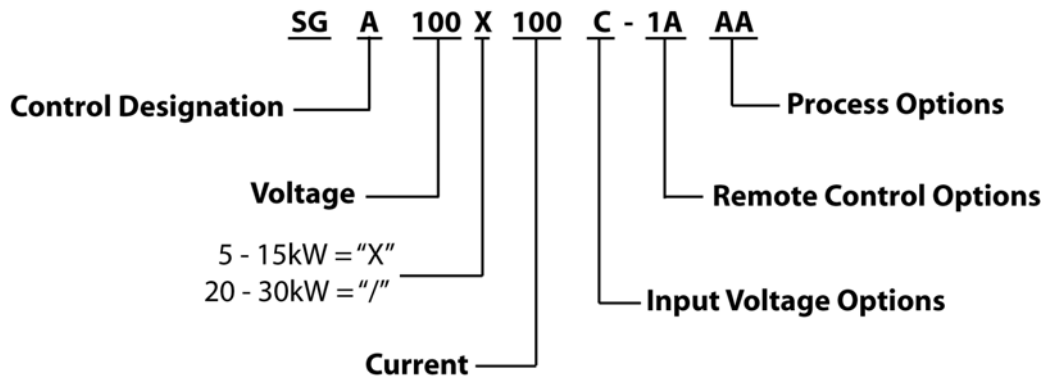

(For units up to 999A, Current is represented in numeric format, e.g., above, "100" represents 100A. For units at 1000A and above, the Current is represented by the format "XKX", e.g., "1K2" represents 1200A).

**Figure 1-1. Model Number Decoding**

## 1.2 SPECIFICATIONS

The following subsections provide environmental, electrical, and physical characteristics for the SGA Series power supplies.

Note: Specifications are subject to change without notice.

Note: The SGA Series power supplies are intended for indoor use only. Please refer to Section 2.3 for use/location requirements.

### 1.2.1 ENVIRONMENTAL CHARACTERISTICS

Parameter	Specification
Temperature Coefficient	0.02%/°C of maximum output voltage rating for voltage set point. 0.03%/°C of maximum output current rating for current set point.
Ambient Temperature	
Operating	0 to 50°C
Storage	-25° to 65°C
Cooling	Internal fans; vents on sides and rear. (Units may be stacked without clearance above or below).
Humidity	95% maximum, non-condensing, 0 to 50°C; 45°C maximum wet-bulb temperature.
Altitude	Operating full power available up to 5,000 feet (1,524m), derate 10% of full power for every 1,000 feet higher non-operating to 40,000 feet (12,192m)
Agency Approvals	CE Mark to the Low Voltage and EMC directives NRTL approved to UL 1012, UL 61010, EN 61010, IEC 61010

### 1.2.2 ELECTRICAL CHARACTERISTICS

The voltage accuracy specifications are valid only with remote sense connected.

Parameter	Specification
Input Power	
Voltage (Standard)	208/230 VAC±10% (tested to 187-253 VAC)
Voltage (Options)	380/400 VAC±10% (tested to 342-440 VAC) 440/480 VAC±10% (tested to 396-528 VAC)
Frequency	47 to 63 Hz, 400 Hz
Phases	3-phase, 3-wire plus ground. Not phase rotation sensitive. Neutral not used.
Front Panel Meter Accuracy	
Voltage	±0.5% of full-scale + 1 digit
Current	±0.5% of full-scale + 1 digit

Parameter	Specification
<b>Load Regulation (Specified at no load to full load, nominal AC input)</b>	
Voltage	0.02% of maximum output voltage (40V – 800V) 0.05% of maximum output voltage (10V – 30V)
Current	0.1% of maximum output current
<b>Line Regulation (Specified <math>\pm 10\%</math> of nominal AC input, constant load)</b>	
Voltage	0.05% of maximum output voltage (10V – 30V) 0.01% of maximum output voltage (40V – 800V)
Current	0.05% of maximum output current
Transient Response	A 50% step load will recover to within 0.75% of original value within 1 ms.
Down Programming	With no load the output will program from 100 to 10% in less than 1.5 seconds
Stability	$\pm 0.05\%$ of set point over 8 hours at fixed line, load, and temperature, using remote sense and after 30 minute warm-up
Remote Control/Monitor	On/Off control via contact closure, 6-120 VDC or 12-240 VAC, and TTL or CMOS switch, output voltage and current monitor, OVP limit set, summary fault status
Power Factor	>0.9 typical for 208/220VAC input (10V – 800V) >0.78 typical for 380/400VAC input (40V – 800V) >0.9 typical for 380/400VAC input (10V – 30V) >0.7 typical for 440/480VAC input (40V – 800V) >0.9 typical for 440/480VAC input (10V – 30V)
Efficiency	87% typical at full load, nominal line
<b>Analog Remote Programming</b>	
<b>Accuracy</b>	
Constant Voltage	$\pm 0.25\%$ of full-scale output for 0-5V range ( $\pm 0.5\%$ 0-10V range)
Constant Current	$\pm 0.8\%$ of full-scale output ( $\pm 1\%$ 0 – 10V range for 10V – 30V)
Overvoltage Protection (OVP)	$\pm 1\%$ of full-scale output
<b>Resistive</b>	
Constant Voltage (0-100%)	0–5 k $\Omega$
Constant Current (0-100%)	0–5 k $\Omega$
<b>Voltage</b>	
Constant Voltage (0-100%)	0–5 VDC or 0–10 VDC
Constant Current (0-100%)	0–5 VDC or 0–10 VDC
Overvoltage Protection (OVP) (5-110%)	0.25–5.5 VDC

Parameter	Specification
Remote Sensing	Terminals are provided to sense output voltage at point of load. Maximum line drop 5% of rated voltage per line for 40-100V models, line drop 1V of rated voltage per line for 10-20V models, 1.5V for 30V models, 2% of rated voltage per line for models 160V and greater. (Greater line drop is allowed, but output regulation specifications no longer apply).
<b>ISOLATED ANALOG CONTROL (OPTION)</b>	
Isolated Analog Control Input (J1) to Output Isolation	600 V Compliant with maximum terminal float voltage. Recommended operation under SELV normal conditions.  (Standard Analog Control Input (J1) signals are referenced to the negative output terminal and are therefore not isolated from the output.)

### 1.2.3 SGA SERIES VOLTAGE AND CURRENT SPECIFICATIONS

Presented here are the voltage and current specification first for the 10V to 30V models and then for the 40V to 800V models.

Voltage	Amperage						Noise** RMS	Noise* P-P
	4 kW	5 kW	8 kW	10 kW	12 kW	15 kW		
0-10V <sup>††</sup>	0-400A	N/A	0-800A	N/A	0-1200A	N/A	20 mV	50 mV
0-15V <sup>††</sup>	267A	N/A	534A	N/A	801A	N/A	20 mV	50 mV
0-20V <sup>††</sup>	N/A	250A	N/A	500A	N/A	750A	20 mV	60 mV
0-30V <sup>††</sup>	N/A	167A	N/A	334A	N/A	501A	20 mV	60 mV

Voltage	Amperage						Noise** RMS	Noise* P-P
	5 kW	10 kW	15 kW	20 kW	25 kW	30 kW		
0-40V	0-125A	0-250A	0-375A	0-500A <sup>†</sup>	0-625A <sup>†</sup>	0-750 <sup>†</sup>	20 mV	75 mV
0-60V	0-83A	0-167A	0-250A	0-333A	0-417A	0-500A	20 mV	75 mV
0-80V	0-63A	0-125A	0-188A	0-250A	0-313A	0-375A	20 mV	100 mV
0-100V	0-50A	0-100A	0-150A	0-200A	0-250A	0-300A	20 mV	100 mV
0-160V	0-31A	0-63A	0-94A	0-125A	0-156A	0-188A	25 mV	150 mV
0-200V	0-25A	0-50A	0-75A	0-100A	0-125A	0-150A	25 mV	175 mV
0-250V	0-20A	0-40A	0-60A	0-80A	0-100A	0-120A	30 mV	200 mV
0-330V	0-15A	0-30A	0-45A	0-61A	0-76A	0-91A	30 mV	200 mV
0-400V	0-12A	0-25A	0-38A	0-50A	0-63A	0-75A	30 mV	300 mV
0-600V	0-8A	0-17A	0-25A	0-33A	0-42A	0-50A	60 mV	350 mV
0-800V	0-6.2A	0-12.5A	0-18.7A	0-25A	0-31.2A	0-37.5A	80 mV	500 mV

\* P-P noise is measured across a 1 uF capacitor at the end of a 6' load cable with the supply operating at full load and at nominal input line voltage.

\*\* RMS noise is measured directly across the output terminals with the supply operating at full load and at nominal input line voltage.

† Power level not available in 6U chassis. In 3U chassis, these power levels can be achieved up to 75 kW by paralleling up to five power supplies. Note that paralleling will increase Ripple and Noise.

†† Models from 10V – 30V not available in 6U chassis.

#### 1.2.4 PHYSICAL CHARACTERISTICS

Dimension	3U Models (10V – 30V)	3U Models (40V – 800V)	6U Models (40V – 600V)
Width	19.00 in (48.3 cm)	19.00 in (48.3 cm)	19.00 in (48.3 cm)
Depth	25.65 in (65.15 cm)	25.46 in (64.7 cm)	27.06 in (68.8 cm)
Height	5.25 in (13.3 cm)	5.25 in (13.3 cm)	10.5 in (26.7 cm)
Weight	(4kW, 10V,15V) ≈<65 lbs (29 kg) (5kW, 20V,30V) ≈<65 lbs (29 kg) (8kW, 10V,15V) ≈<85 lbs (39 kg) (10kW, 20V,30V) ≈<85 lbs (39 kg) (12kW, 10V,15V) ≈<110 lbs (50 kg) (15kW, 20V,30V) ≈<110 lbs (50 kg)	(5kW) ≈ 40 lbs (18 kg) (10kW) ≈ 60 lbs (27 kg) (15kW) ≈ 80 lbs (36 kg)	(20 KW) ≈ 120 lbs (54 kg) (25 kW) ≈ 140 lbs (64 kg) (30kW) ≈ 160 lbs (73 kg)

This page intentionally left blank.

## SECTION 2 INSTALLATION

### 2.1 INSPECTION

Inspect the shipping carton for possible damage before unpacking the unit. Carefully unpack the equipment. Save all packing materials until inspection is complete. Verify that all items listed on the packing slips have been received. Visually inspect all exterior surfaces for broken knobs, connectors, or meters. Inspect for dented or damaged exterior surfaces. External damage may be an indication of internal damage. If any damage is evident, immediately contact the carrier that delivered the unit and submit a damage report. Failure to do so could invalidate future claims. Direct repair issues to Customer Service at 858-458-0223 (local) or 1-800-733-5427(toll free).

### 2.2 CONTENTS OF SHIPMENT

Depending on the model, configuration, and options available for your SGA Series power supply, the ship kit may include additional parts and accessories. At a minimum, the ship kit that accompanies your SGA Series power supply includes the following items:

- AMETEK Manuals CD-ROM, Part No. M550008-01, containing this manual, SGA Series DC Power Supplies Operation Manual (Part No. M550129-01) and the SG Series IEEE 488.2/RS232 Option and Ethernet Option Programming Manual (Part No. M550129-03)
- Sense mating connector (Molex P/N 39-01-4031) with loose contacts (Molex P/N 39-00-0182)
- J1 mating connector (Cinch P/N DB25P or equivalent) normally shipped attached to rear panel J1
- Back shell for J1 (DB25) mating connector (Cinch P/N DCH-B-001 or equivalent)

- Bolt, lock washer, and nut for output power connections:

20–30 kW: 3/8-16UNC-2B x 1/4", 4 ea for AC input  
 3/8-16UNC-2B x 3/8", 2 ea for DC output

- Black screw, 10-32UNC-2B x 1/2", front panel rack fastener:





5–15 kW (40-800V): 4 ea

4-15Kw (10-30v): 1/2-13UNC-2B x 1.5" long, 4 ea

20–30 kW: 8 ea

**Note:** If any of these parts are missing, please contact Customer Service at 858-458-0223 (local) or 1-800-733-5427 (toll free).

## 2.3 LOCATION AND MOUNTING

	<b>WARNING!</b> To reduce the risk of fire or electrical shock, install the SGA Series unit in a temperature and humidity controlled indoor area, free of conductive contaminants.
	<b>CAUTION!</b> The unit should be provided with proper ventilation. The rear and both sides of the unit should be free of obstructions. To ensure proper airflow, a minimum 4" clearance from the rear air outlet is required. The unit should not be installed in a raised ambient temperature greater than 50°C.
	<b>CAUTION!</b> This unit is intended for installation in a protected environment. No user serviceable parts inside. Service to be performed by qualified personnel only.
	<b>CAUTION!</b> Ensure that the concentration of ozone is limited to a safe value. The recommended long-term exposure limit for ozone is 0.1 PPM (0.2 mg/m <sup>3</sup> ).
	<b>BURN HAZARD!</b> Hot Surface Warning. Allow to cool before servicing.

Please refer to sections 2.7 and 2.8 for dimensional and installation drawings.

### 2.3.1 RACK

The SGA Series models are designed for mounting in a standard 19-inch equipment rack. If additional instrumentation is mounted in the rack, no additional clearance is required above or below units in the SGA Series.

1. Support the unit using rack mount slides or appropriate L brackets (suggested parts are listed below).

Rack Mount Slide Kit:

4–15kW units P/N K550212-01  
20–30kW units P/N K550213-01

2. Secure the unit in place using the screws provided.

### 2.3.2 6U CHASSIS REMOVAL FROM RACK

The slides have a Front Disconnect Feature and lock at full extension.

To return the chassis back into the rack from full extension, depress the flat steel spring inward (located on the slides) and push the chassis back.

To disconnect and remove the chassis from the rack, depress the flat steel spring inward (located on the slides) and pull the chassis forward.



**WARNING!**

A minimum three-person lift is required for the 6U SGA Series unit, which weighs up to 160 lbs (73kg) depending on the model.

When the chassis is at full extension, the flat springs are located approximately one (1) inch behind the front EIA RETMA rails. Access the springs with a flat blade screwdriver or similar device to release from lock-out or to remove the chassis from the rack.

The slides can be mounted to the chassis with this spring oriented on the top or the bottom of the slide.

## 2.4 INPUT/OUTPUT CONNECTIONS



**WARNING!**

High voltage present! Risk of electrical shock. Do not remove cover. Refer to qualified service personnel.

For permanently connected equipment, incorporate a readily accessible disconnect device in the fixed wiring. For pluggable equipment, install the socket outlet near the equipment and in an easily accessible location.

Table 2–1 lists all external connections for the SGA Series models. Table 2–2 and Table 2–3 provide input and output connection descriptions by power supply type. Section 2.8 provides a drawing of the rear panel input/output connector locations.



	<p><b>CAUTION!</b> Proper connection to the mains requires a circuit breaker or fuse with a rating of 25% over the maximum input line currents listed in Table 2–6.</p>
	<p><b>WARNING!</b> Under no condition should the negative output terminal exceed 300V to earth ground.</p>
	<p><b>CAUTION!</b> Floating the negative output terminal floats the power supply’s internal control circuitry common level to the same potential as the negative output terminal. On a standard non-isolated supply the common of the analog control connector (J1) floats at the same potential as the negative output terminal. Damage may occur if the non-isolated analog control connector of a supply is connected to an external ground referenced input/output device. Such a connection creates ground loop currents. To correct ground loop problems the Isolated Analog option is advised in order to isolate the external ground reference signals from the internal control circuitry of the supply.</p>

Table 2–1 provides details of the SGA Series input and output connectors and their functions. Table 2–2 describes the input connector types and Table 2–3 describes the output connector types.

Connector	Function	Connects To
FL1 – AC FL1 – AC FL1 – AC Chassis - GND	Prime AC Power Input See Table 2–2. Not phase rotation sensitive. Neutral not used.	208/220 VAC (Std) 380/400 VAC (Option) 440/480 VAC (Option) 47-63 Hz, 400 Hz
Pos. Bus Bar Neg. Bus Bar Pos. Bus Bar Neg. Bus Bar	Output Power: 3U models (see Table 2–3)  6U models (see Table 2–3)	User load(s)
ANALOG CONTROL Connector (J1)	Control Interface	See Table 3–1 for description
Sense Connector	Used for remote sense	Refer to Section 3.6
Parallel In-Out	Used for parallel operation	Refer to Section 3.10

**Table 2–1. 5kW to 15kW and 20kW to 30kW Series Input/Output Connectors**

Power Supply Type	Connection Description
4 kW to 15 kW	Feed through high current terminal block
20 kW to 30 kW	Bus Bar with holes for 1/4"–20 bolts

**Table 2–2. Input Connections**

Power Supply Type	Connection Description
4 kW to 15 kW	Bus Bar with two holes for each potential terminal 0.594". (Models 10V-30V)
5 kW to 15 kW	Bus Bar with holes for 3/8" bolts (40V-600V) Bronze studs, 1/4-20 (800V model only)
20 kW to 30 kW	Bus Bar with holes for 3/8" bolts Bronze studs, 1/4-20 (800V model only)

**Table 2–3. Output Connections**



**CAUTION!**

Prevent damage to the unit: follow torque specifications, use correct size wire ferrule (if used), and proper size ferrule crimping tool.

**TORQUE SPECIFICATIONS**

- The unit's Phoenix Connectors require 18 in-lb to 20 in-lb (2 Nm to 2.3 Nm) torque.
- Wire ferrules are recommended; their size must match the wire gauge.
- Crimp tool size must be appropriate to the ferrule size.
- Wire insulation should be stripped back no more than 5/8 inch for the ferrule.

For more information on this AC input connector, please look up Phoenix Contact part number HDFKV 16 at [www.phoenixcontact.com](http://www.phoenixcontact.com).

## 2.5 WIRE SELECTION

Care must be taken to properly size all conductors for the input and output of the power supply. This section provides guidance in the selection of wire size. Note that cables with Class B or C stranding should be used. Fine stranded cables should not be used unless crimp-on lugs or ferrules are used that are approved for fine stranded cables.

### 2.5.1 WIRE SIZE

The tables below will assist in determining the appropriate wire size for both the input and output connections Table 2–4 below gives *minimum* recommended wire size. This table is derived from the National Electrical Code; it is for reference only. Local laws and conditions may have different requirements. Note that these recommendations are for copper wire only. For higher ratings, wires can be paralleled; refer to the National Electrical Code.

Size	Temperature Rating of Copper Conductor			
	60°C	75°C	85°C	90°C
AWG MCM	Types: RUW, T, TW, UF	Types: FEPW, RHW, RH, RUH, THW, THWN, XHHW, USE, ZW	Types: V, MI	Types: TA, TBS, SA, AVB, SIS, FEP, FEPB, RHH, THHN, XHHW
	<b>Current Rating</b>			
14	20	20	25	25
12	25	25	30	30
10	30	35	40	40
8	40	50	55	55
6	55	65	70	75
4	70	85	95	95
3	85	100	110	110
2	95	115	125	130
1	110	130	145	150
0	125	150	165	170
00	145	175	190	195
000	165	200	215	225
0000	195	230	250	260

**Table 2–4. Minimum Wire Size**

When determining the optimum cable specification for your power applications, the same engineering rules apply whether going into or out of an electrical device. Thus, this guide applies equally to the input cable and output cable for this Sorensen instrument and application loads.

Power cables must be able to safely carry maximum load current without overheating or causing insulation destruction. It is important to everyday performance to minimize IR (voltage drop) loss within the cable. These losses have a direct effect on the quality of power delivered to and from instruments and corresponding loads.

When specifying wire gauge, consider the operating temperature. Wire gauge current capability and insulation performance drops with the increased temperature developed within a cable bundle and with increased environmental temperature. Thus, short cables with generously derated gauge and insulation properties are recommended for power source applications.

Be careful when using published commercial utility wiring codes. These codes are designed for the internal wiring of homes and buildings and accommodate the safety factors of wiring loss, heat, breakdown insulation, aging, etc. However, these codes consider that up to 5% voltage drop is acceptable.

Such a loss directly detracts from the quality performance specifications of this Sorensen instrument. Also, consider how the wiring codes apply to bundles of wire within a cable arrangement.

In high performance applications requiring high inrush/ transient currents, additional consideration is required. The cable wire gauge must consider peak voltages and currents, which may be up to ten times the average values. An underrated wire gauge adds losses, which alter the inrush characteristics of the application and thus the expected performance.

Table 2–5 presents wire resistance and resulting cable voltage drop at maximum rated current.

<b>Column 1</b>	<b>Column 2</b>	<b>Column 3</b>	<b>Column 4</b>
<b>Size</b>	<b>Amperes</b>	<b>Ohms/100 Feet</b>	<b>Voltage Drop/100 Feet</b>
14	20	0.257	5.14
12	25	0.162	4.05
10	30	0.102	3.06
8	40	0.064	2.56
6	55	0.043	2.36
4	70	0.025	1.75
2	95	0.015	1.42
1/0	125	0.010	1.25
3/0	165	0.006	1.04

**Table 2–5. Wire Resistance and Voltage Drop**

Refer to Table 2–6 for AC input current requirements and Section 1.2.3 for output current requirements.

Model Voltage Range	AC Input Option Code	Input V	Input Line Current						Unit of Measure
			5 kW	10 kW	15 kW	20 kW	25 kW	30 kW	
40V-800V	C	200-240VAC	21	41	62	83	103	124	Amps AC per phase
	D	360-440VAC	14	27	40	54	67	80	
	E	480VAC	13	26	39	52	65	78	
			4 kW	8 kW	12 kW	5 kW	10 kW	15 kW	
10V-15V	C		18	34	50	N/A	N/A	N/A	
	D		10	19	27	N/A	N/A	N/A	
	E		8	15	21	N/A	N/A	N/A	
20V-30V	C		N/A	N/A	N/A	22	43	62	
	D		N/A	N/A	N/A	12	23	34	
	E		N/A	N/A	N/A	10	19	27	

**Table 2–6. Maximum AC Current Ratings**

Refer to Table 2–7 for input/output lug recommendations.

Lug Manufacturer	3U Models Input/Output	6U Models Input/Output
Panduit	“PN” Series or equivalent ”LCAN” Series for higher current	“LCA” Series or equivalent
<b>Note:</b> Contact lug manufacturer for recommended crimping tool.		

**Table 2–7. Recommended Lugs**

The recommended tools for crimping and extraction of the sense connector pins are listed below in Table 2–8.

Tool	Manufacturer	Manufacturer P/N
Crimping	Molex	11-01-0197
Extracting	Molex	11-03-0044

**Table 2–8. Recommended Sense Connector Tools**

## 2.6 LOAD CONSIDERATIONS

This section provides guidelines for using properly rated diodes to protect the power supply from damage while driving inductive loads.

### 2.6.1 INDUCTIVE LOADS

To prevent damage to the power supply from inductive kickback, connect a diode (rated at greater than the supply's output voltage and current) across the output. Connect the cathode to the positive output and the anode to return. Where positive load transients such as back EMF from a motor may occur, a second diode in series with the output is recommended to protect the power supply.

#### BLOCKING AND FREE WHEELING DIODES

The Peak Reverse Voltage ratings should be a minimum of 2-3 times the Power Supply maximum output voltage. The Continuous Forward Current ratings should be a minimum of 1.5 times the Power Supply maximum output current. Heatsink may be required. There also may be a need for higher voltage rated parts, dependent on load circuit design and inductor values.

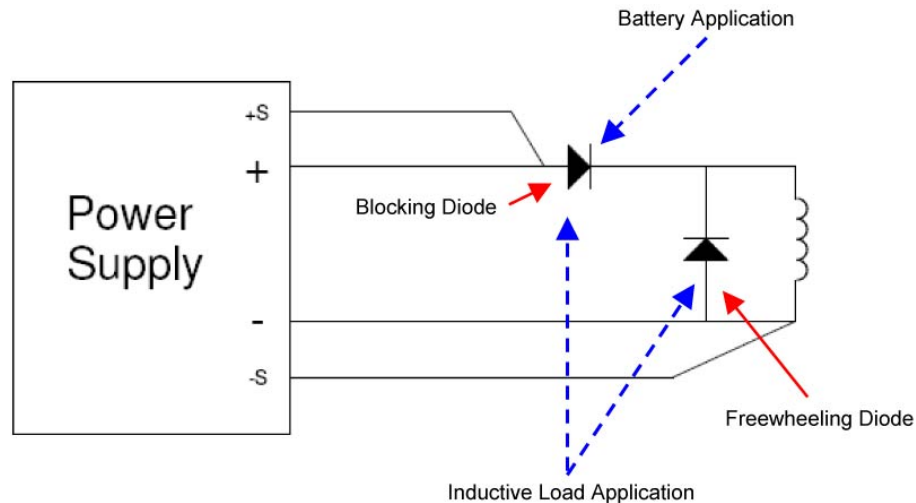

**Figure 2-1. Diode Connection**

## 2.7 OUTLINE DRAWINGS

Figure 2-2 and Figure 2-4, next, show the outlines and overall dimensions of the 3U and 6U models of the SGA Series product line. Figure 2-5, Figure 2-7, Figure 2-8, and Figure 2-10 provide detailed information for installation purposes.

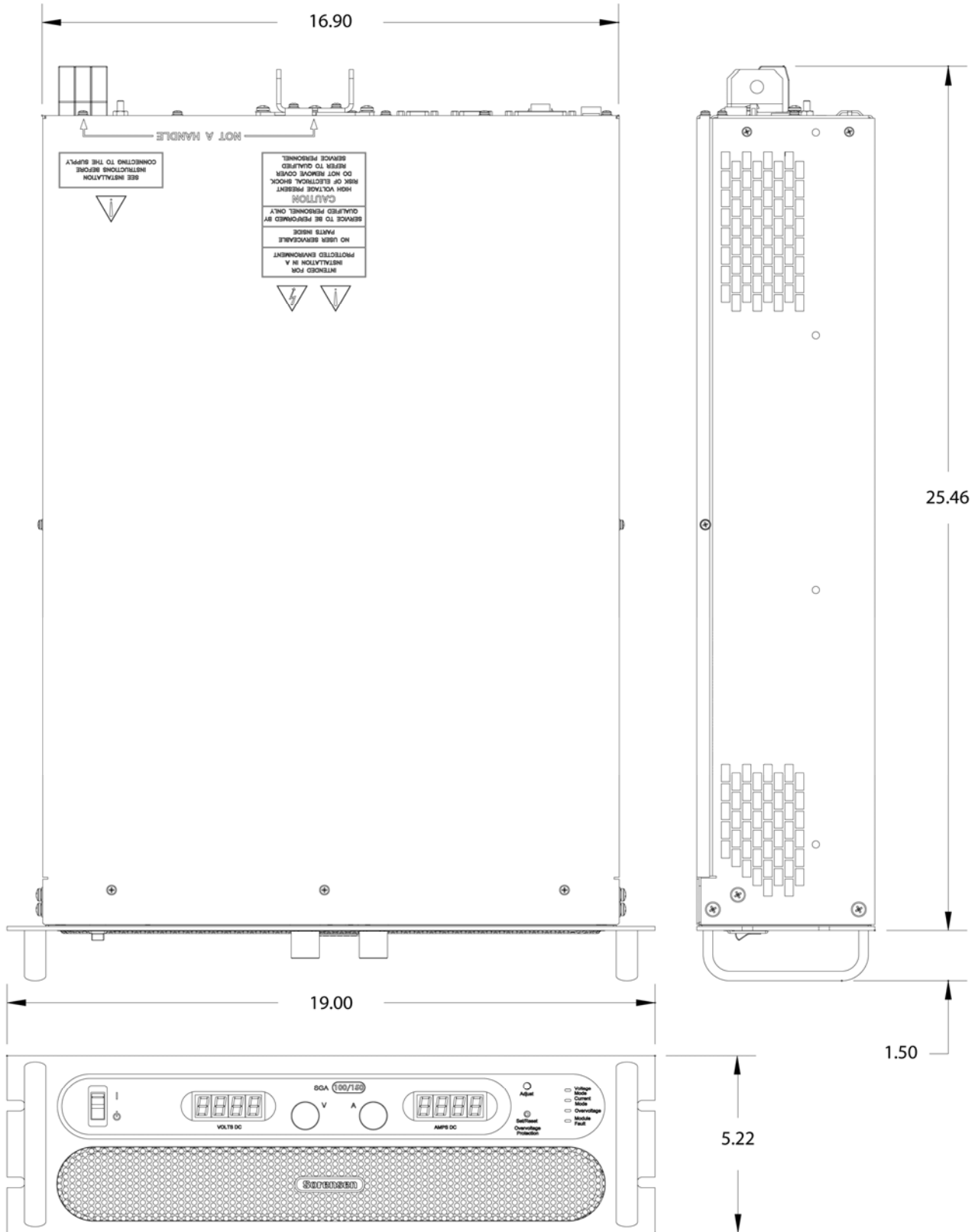

Figure 2-2. SGA Dimensions, 3U Model, 5kW to 15kW (40V-800V)

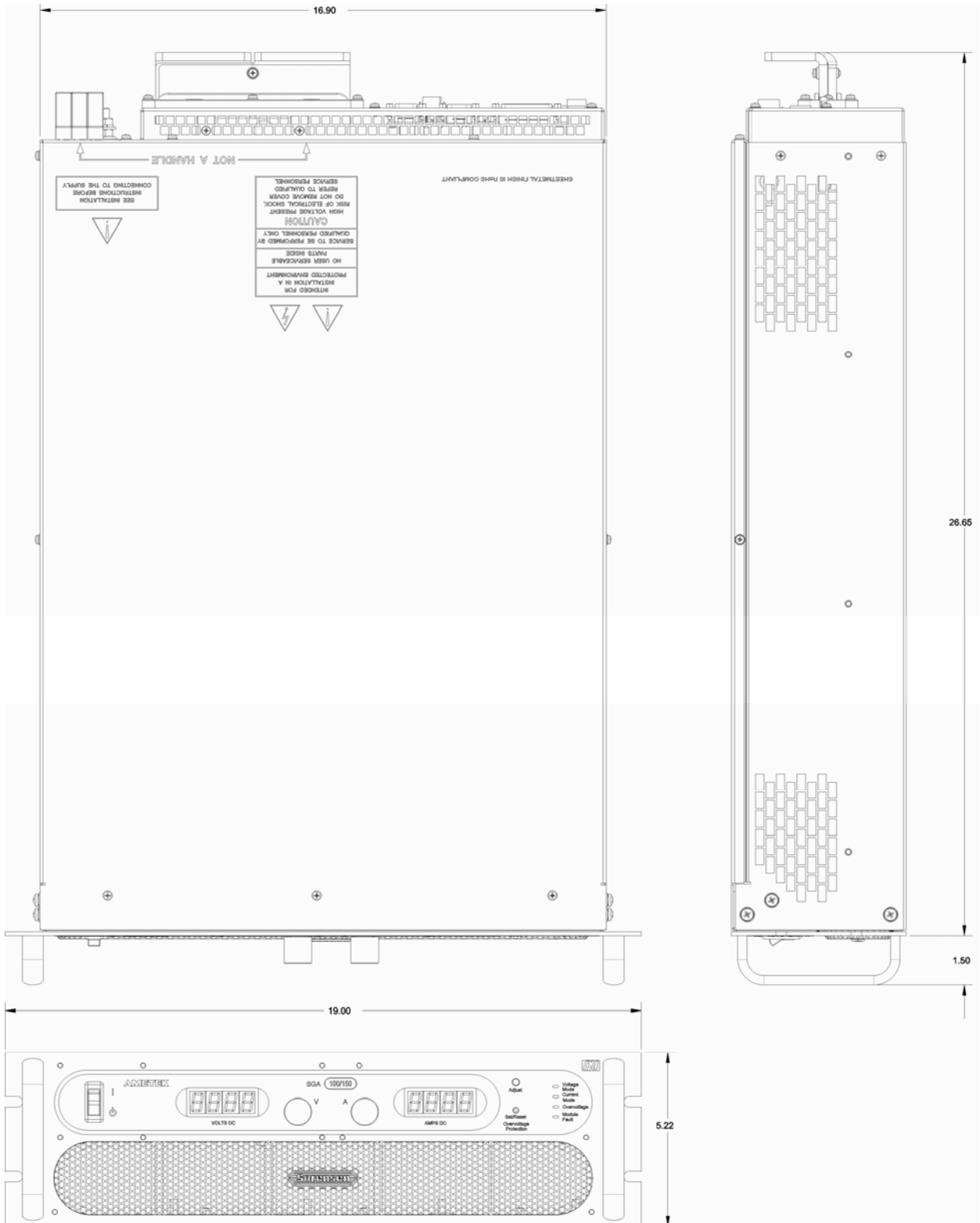

Figure 2-3. SGA Dimensions, 3U Model, 4kW to 15kW (10V-30V)

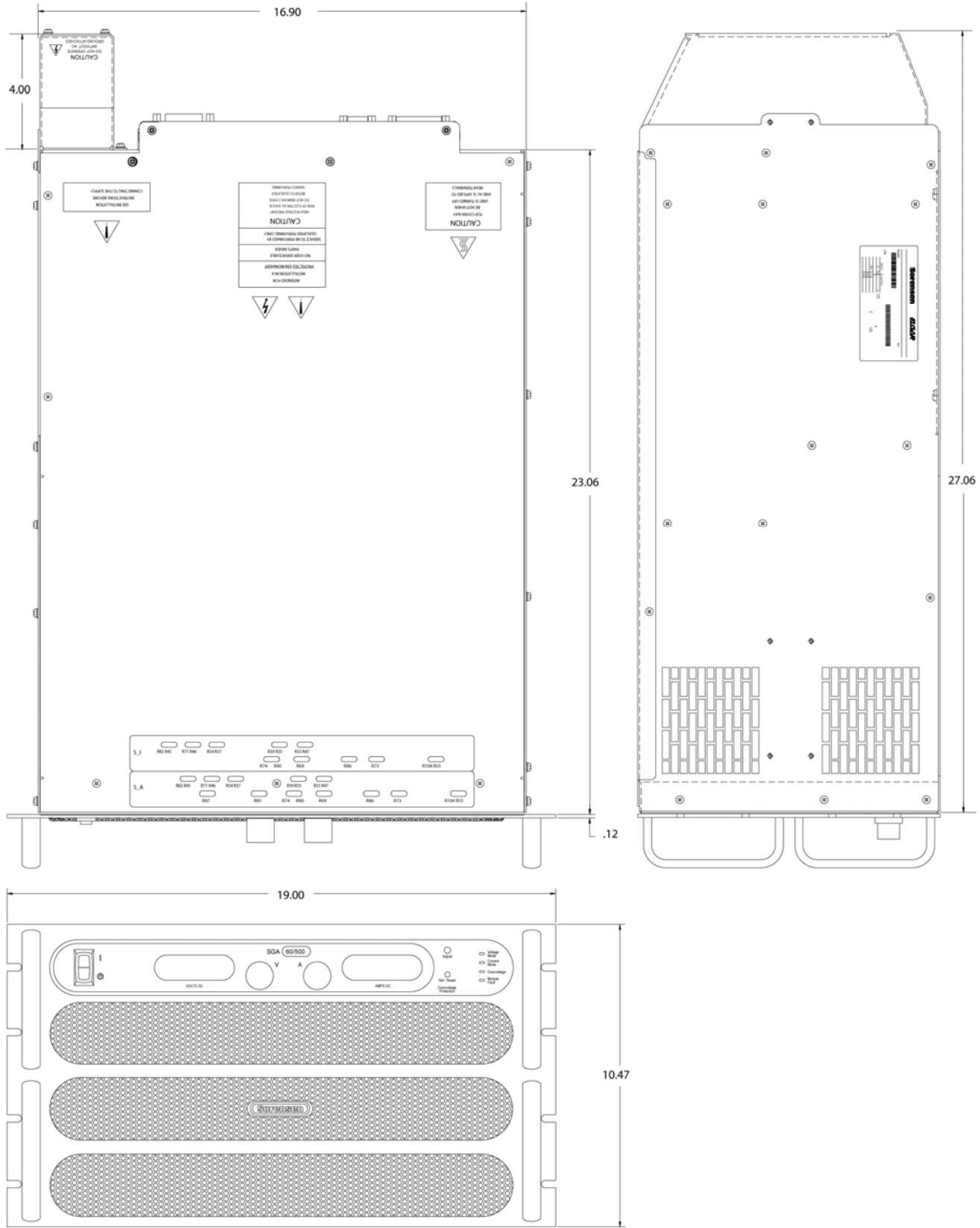

Figure 2-4. SGA Dimensions, 6U Models, 20kW to 30kW

## 2.8 INSTALLATION DRAWINGS

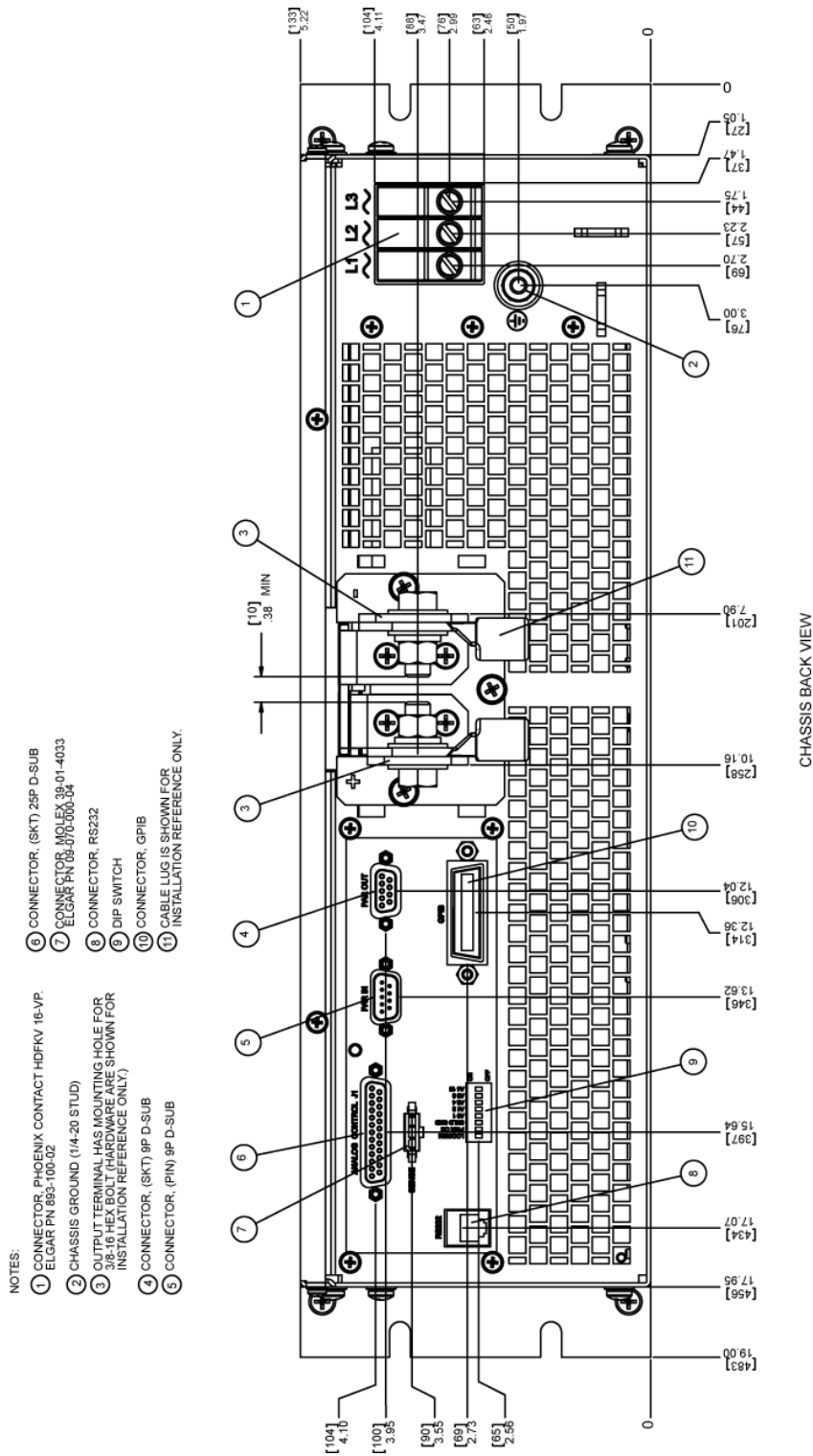

Figure 2-5. Rear Panel Input-Output Connector Locations, Models 40V-600V

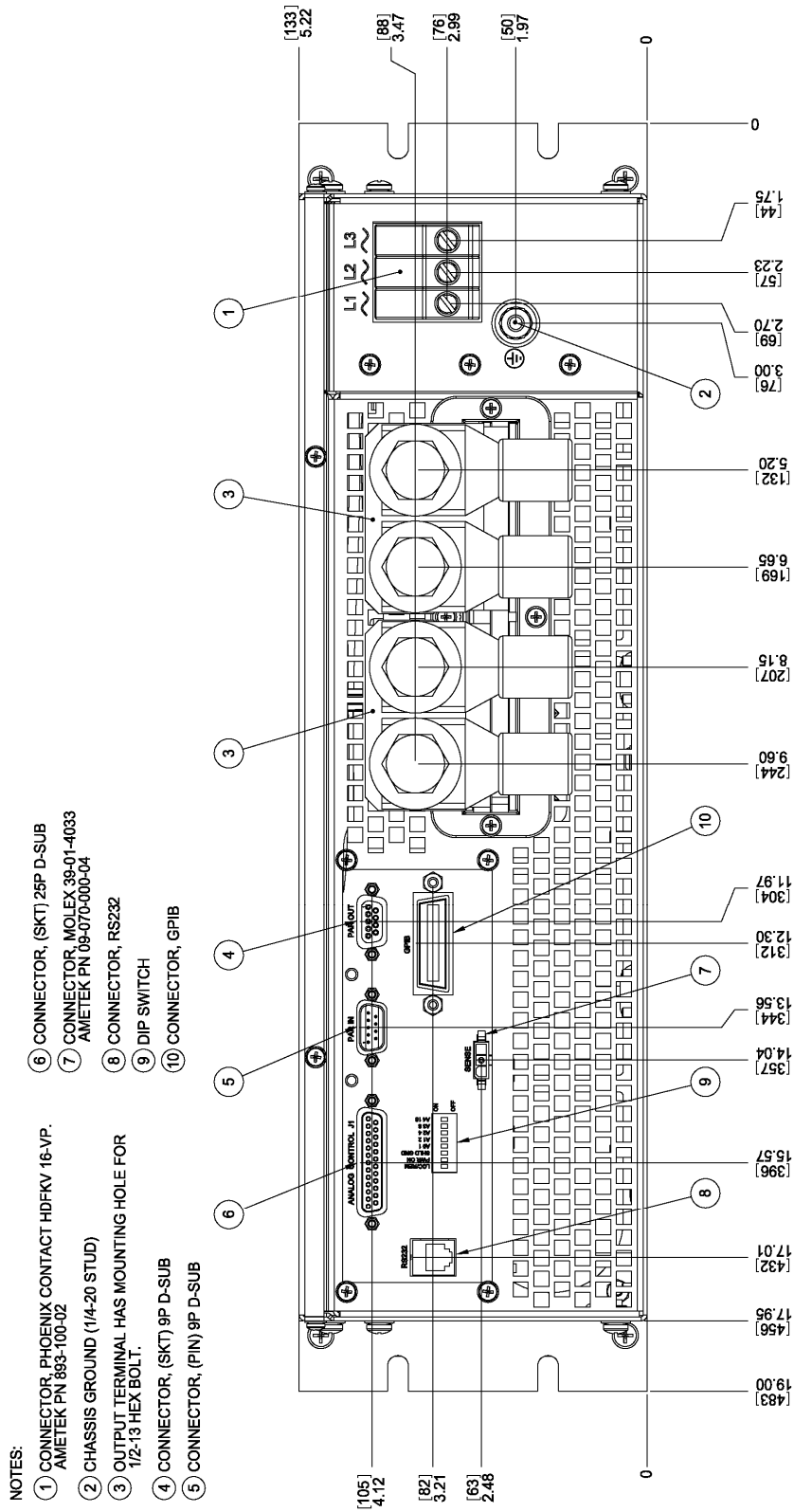

Figure 2-6. Rear Panel Input-Output Connector Locations, Models 10V-30V

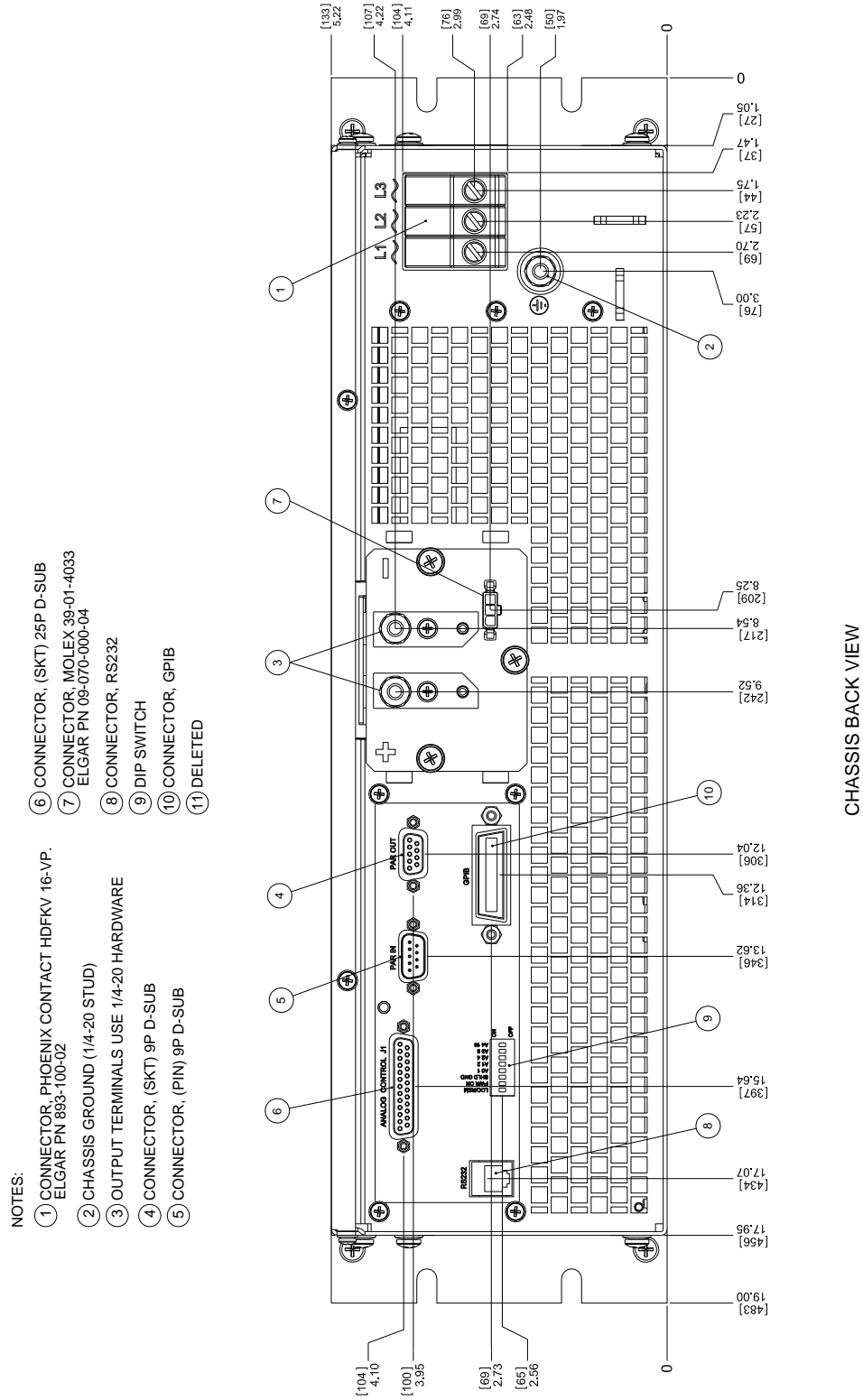

Figure 2-7. 800V Rear Panel Input-Output Connector Locations

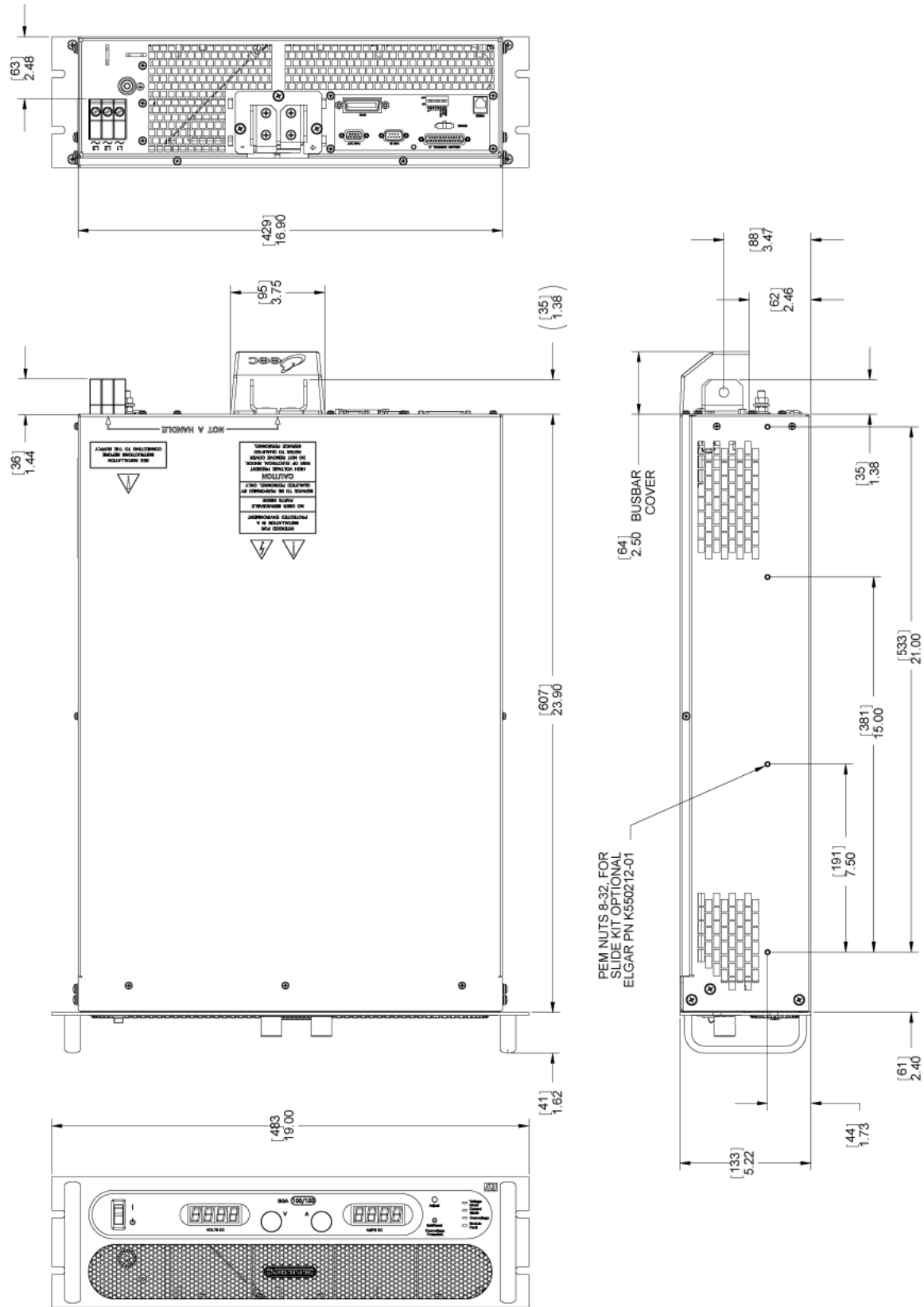

Figure 2-8. SGA Detailed Chassis Dimensions for Installation, Models 40V-600V



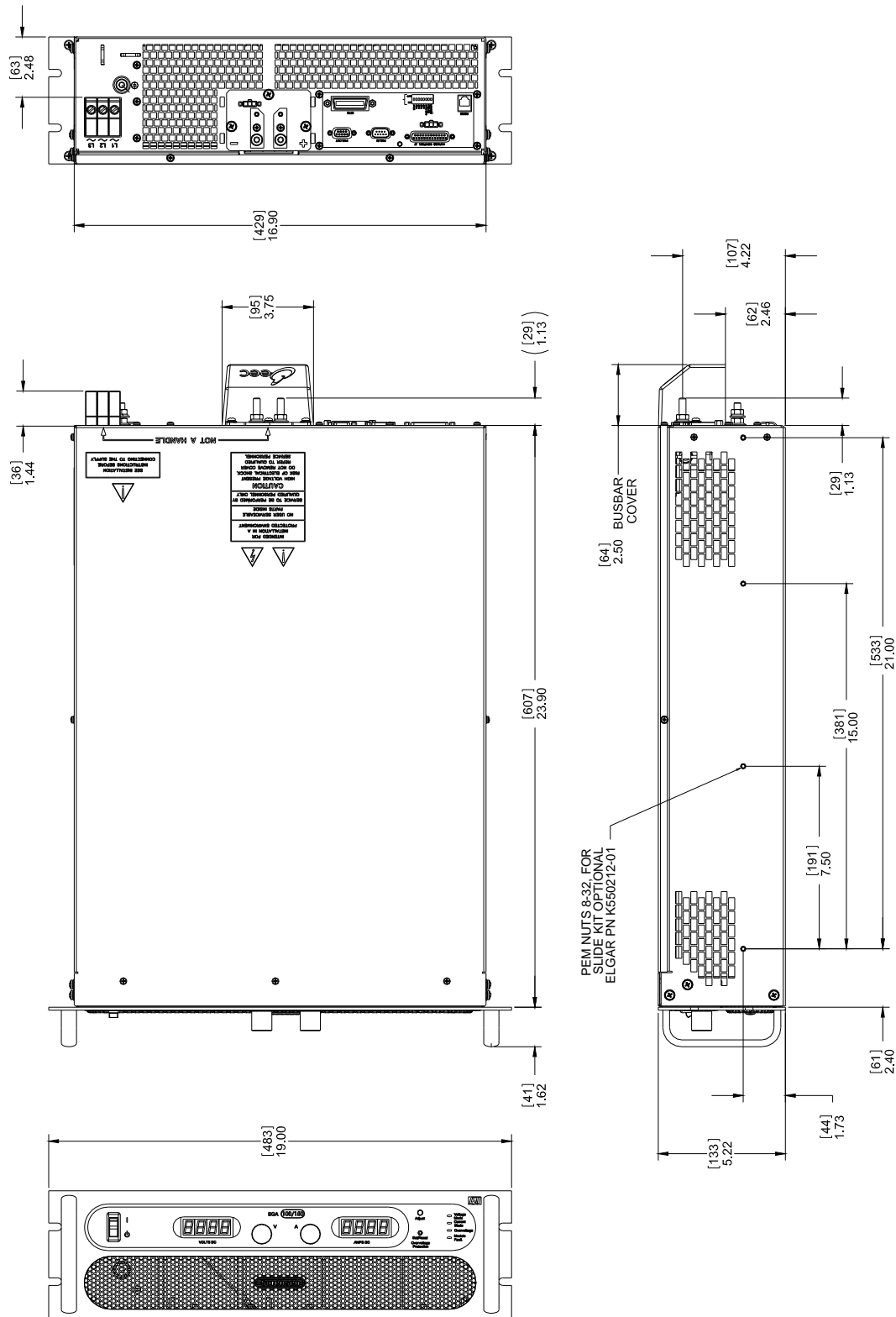

Figure 2-10 SGA 800V Detailed Chassis Dimensions for Installation

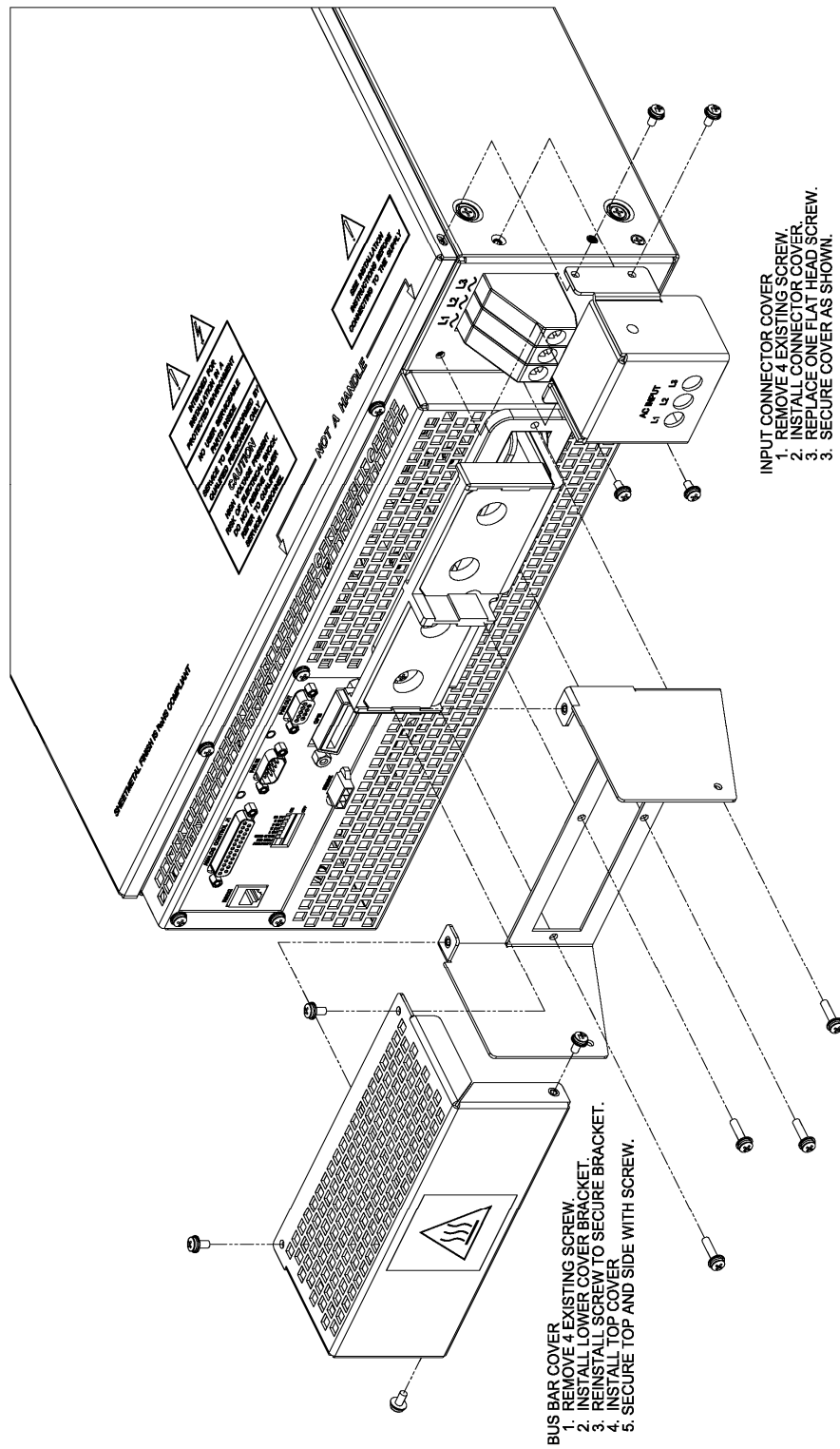

Figure 2-11. Instructions for Assembly of AC and DC Covers

DC cover can be used in SGA 10V-30V models only.  
AC cover can be used in all 3U chassis of SGA family.

# SECTION 3 OPERATION

## 3.1 INTRODUCTION

The SGA series provides simplicity and ease of analog front panel potentiometer controls. LED screens display bright, easy-to-read voltage and current output measurements. This section provides detailed information on the operation of the SGA series.



### **WARNING!**

The power-up factory default state is output enabled.

## 3.2 CONTROLS AND INDICATORS

### 3.2.1 FRONT PANEL

The following pages provide illustrations and tables of corresponding descriptions of the various SG Series rear panel configurations.

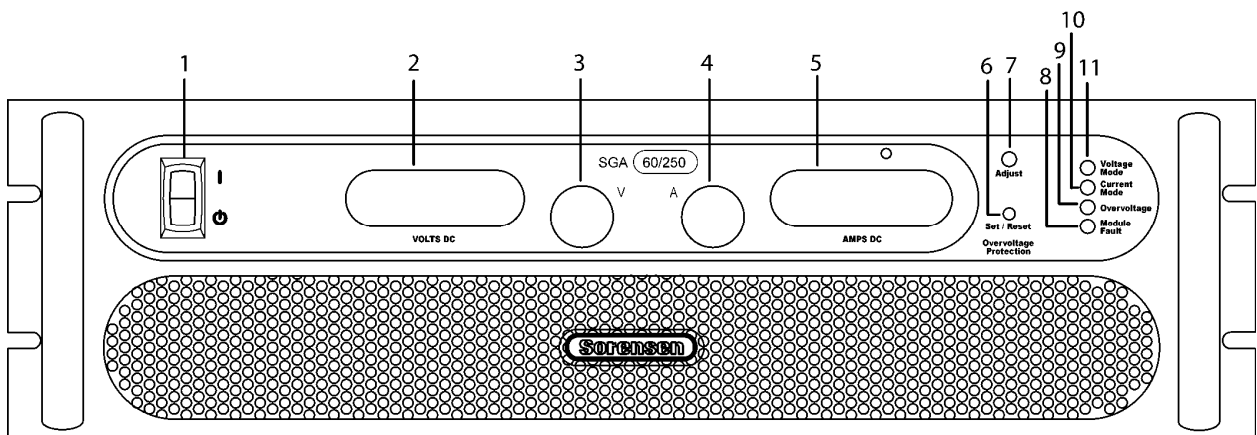

**Figure 3-1. SGA Front Panel Controls and Indicators (3U model shown)**

Figure 3-1 descriptions:

- 1 **ON/OFF Switch** Two-position switch enables or disables the power supply.  
 **WARNING:** *OFF does not remove voltage from the input terminal blocks. Remove external power before servicing the unit.*
- 2 **Voltage Display** 3½ digit green LED screen displays the supply's DC output voltage. Also displays the OVP level when pressing the Set/Reset button.
- 3 **Voltage (V) Knob** 10-turn adjustment sets the output voltage. (Optional shaft locks not shown. Please see Section 3.1.1).
- 4 **Current (A) Knob** 10-turn adjustment sets the output current. (Optional shaft locks not shown. Please see Section 3.1.1).
- 5 **Current Display** 3½ digit green LED display indicates the DC output current of the supply.
- 6 **Set/Reset Button** Press to display Overvoltage Protection level on the Voltage display. Press and hold for 7 seconds to reset OVP condition.
- 7 **Adjust Potentiometer** Adjusts the overvoltage trip level.
- 8 **Module Fault LED** Lights yellow to indicate an internal fault such as bias supply, thermal, or converter failure.
- 9 **Overvoltage LED** Lights red when output voltage has exceeded preset level, and power supply output is turned off.
- 10 **Current Mode LED** Lights green when in the Constant Current mode of operation. When in the Constant Current mode, the output current will regulate to the set value and the output voltage will vary with the load.
- 11 **Voltage Mode LED** Lights green when in the Constant Voltage mode of operation. When in the Constant Voltage mode, the output voltage will regulate to the set value and the Current value will vary with the load.

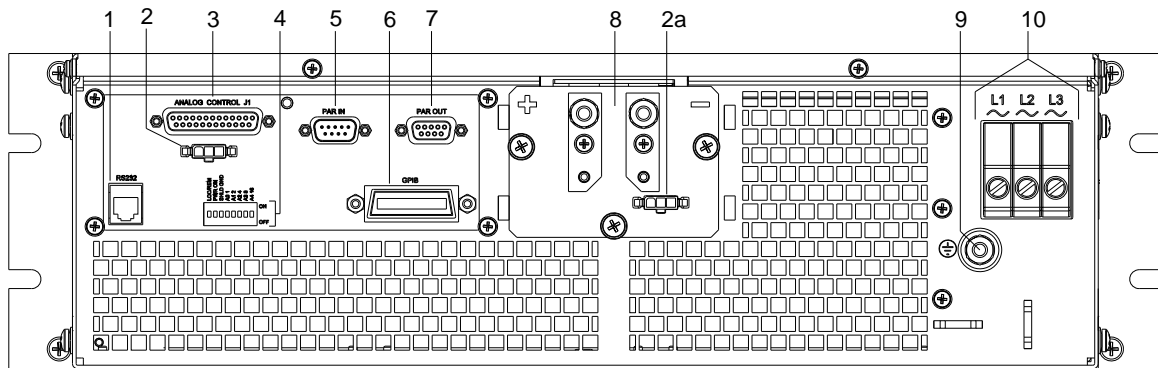

**Figure 3-2. SG Rear Panel with GPIB Option (40V-800V)**

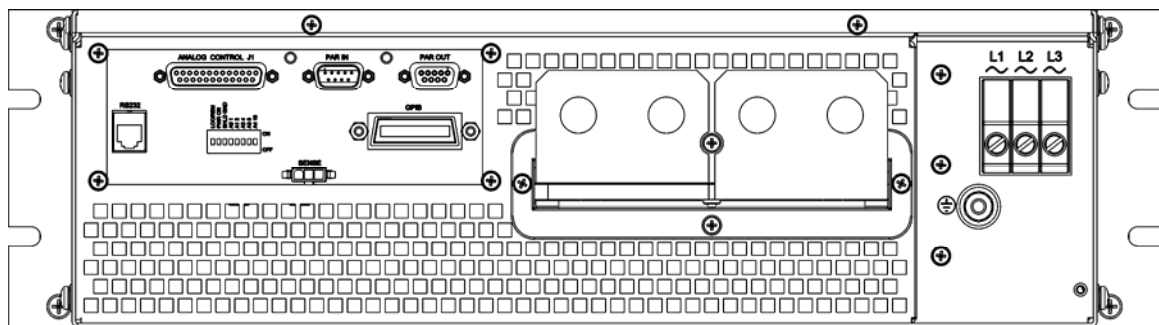

**Figure 3-3. SG Rear Panel with GPIB Option (10V-300V)**

Figure 3-2 and Figure 3-3 descriptions:

- |    |                               |  |
|----|-------------------------------|--|
| 1  | <b>RS232 Connector</b>        | Connector for remote control   |
| 2  | <b>SENSE Connector</b>        | J3 Input connector for load voltage sensing to correct for line drops in the load cables (see Section 3.6).  |
| 2a | <b>HV SENSE Connector</b>     | J3 Input connector for load voltage sensing, 800V models only.   |
| 3  | <b>ANALOG CONTROL</b>         | J1 I/O connector for input programming and analog output monitoring signals as well as status indication and remote shutdown signals. See Table 3–1 for individual pin descriptions. |
| 4  | <b>Configuration Switch</b>   | Four–position DIP switch to configure the unit with a GPIB option.   |
| 5  | <b>Parallel In Connector</b>  | Allows master/slave configuration of up to five units when connected to another unit's Parallel Out connector<br>See Section 3.10.   |
| 6  | <b>GPIB Connector</b>         | Connector for remote control.  |
| 7  | <b>Parallel Out Connector</b> | Allows master/slave configuration of up to five units when connected to another unit's Parallel In connector.<br>See Section 3.10.   |
| 8  | <b>Output Bus Bars</b>        | Positive (+) and negative (–) outputs.   |
| 9  | <b>Ground</b>                 | Connection for ground wire.  |
| 10 | <b>AC Input Connectors</b>    | Connection for 3-phase AC.   |

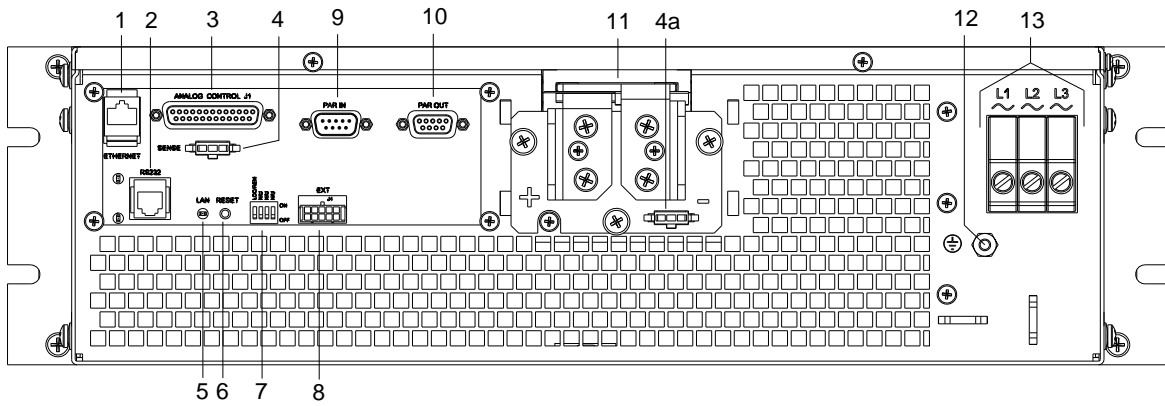

**Figure 3-4. SG Rear Panel with Ethernet Option (40V-800V)**

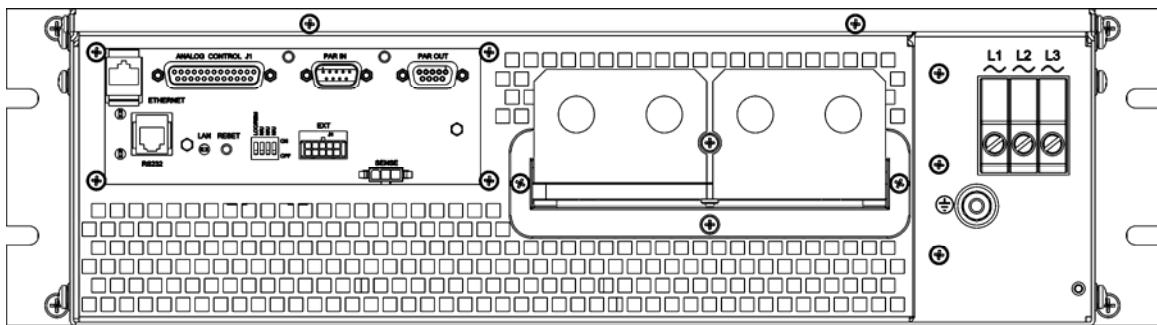

**Figure 3-5. SG Rear Panel with Ethernet Option (10V-30V)**

Figure 3-4 and Figure 3-5 descriptions:

<b>1</b>	<b>ETHERNET Connector</b>	Connector for remote control via Ethernet.
<b>2</b>	<b>RS232 Connector</b>	Connector for remote control
<b>3</b>	<b>ANALOG CONTROL</b>	J1 I/O connector for input programming and analog output monitoring signals as well as status indication and remote shutdown signals. See Table 3–1 for individual pin descriptions.
<b>4</b>	<b>SENSE Connector</b>	J3 Input connector for load voltage sensing to correct for line drops in the load cables (see Section 3.6).
<b>4a</b>	<b>HV SENSE Connector</b>	J3 Input connector for load voltage sensing, 800V models only.
<b>5</b>	<b>LAN</b>	LED steady-lit indicates Network connectivity; blinking indicates “Instrument ID” (See SG Series Programming Manual).
<b>6</b>	<b>RESET Switch</b>	Returns configuration parameters to factory default settings.
<b>7</b>	<b>Configuration Switch</b>	Four–position DIP switch to configure the unit with a Remote Digital Programming option.
<b>8</b>	<b>External User Connector</b>	Provides external auxiliary control signals.
<b>9</b>	<b>Parallel In Connector</b>	Allows master/slave configuration of up to five units when connected to another unit’s Parallel Out connector See Section 3.10.
<b>10</b>	<b>Parallel Out Connector</b>	Allows master/slave configuration of up to five units when connected to another unit’s Parallel In connector. See Section 3.10.
<b>11</b>	<b>Output Bus Bars</b>	Positive (+) and negative (–) outputs.
<b>12</b>	<b>Ground</b>	Connection for ground wire.
<b>13</b>	<b>AC Input Connectors</b>	Connection for 3-phase AC.

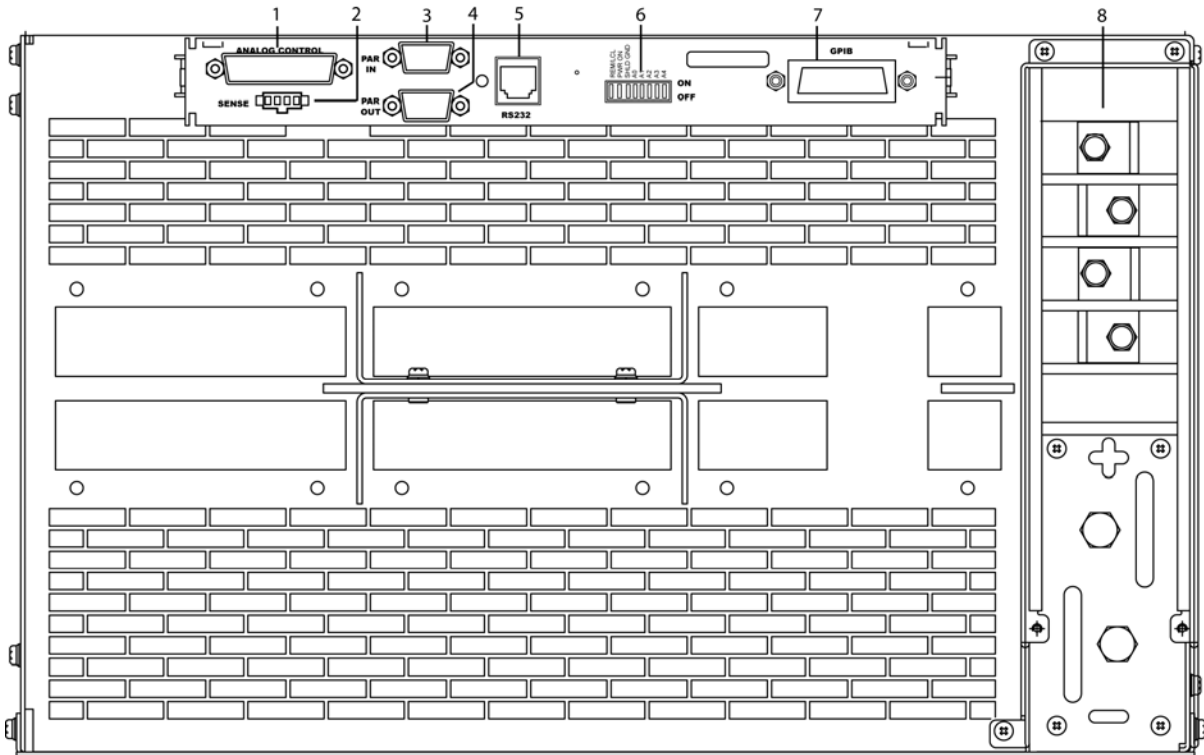

**Figure 3-6. SGA 6U Rear Panel with GPIB/RS232 Option Connectors**

Figure 3-6 descriptions:

- |          |                             |  |
|----------|-----------------------------|--|
| <b>1</b> | <b>ANALOG CONTROL</b>       | J1 I/O connector for input programming and analog output monitoring signals as well as status indication and remote shutdown signals. See Table 3-1 for individual pin descriptions. |
| <b>2</b> | <b>SENSE Connector</b>      | J3 input connector for load voltage sensing to correct for line drops in the load cables (see Section 3.6).  |
| <b>3</b> | <b>PARALLEL IN</b>          | Connector allowing master/slave configuration of up to five units when connected to another unit's PARALLEL OUT connector (see Section 3.10).  |
| <b>4</b> | <b>PARALLEL OUT</b>         | Connector allowing master/slave configuration of up to five units when connected to another unit's PARALLEL IN connector (see Section 3.10).   |
| <b>5</b> | <b>RS232 Connector</b>      | Connector for remote control.  |
| <b>6</b> | <b>Configuration Switch</b> | Eight-position DIP switch to configure an SGA Series unit with a Remote Digital Programming option.<br><b>Note:</b> Some models are designed with a four-position DIP switch.        |
| <b>7</b> | <b>GPIB Connector</b>       | Connector for remote control.  |
| <b>8</b> | <b>AC Input Bus Bars</b>    | Connection for 3-phase AC and Ground.  |

### 3.2.2 SHAFT LOCK (OPTION)

This option replaces the standard control knobs with a two-piece shaft lock. These are installed over the voltage and current adjustment potentiometer shafts to prevent rotating under conditions of shock, vibration, or accidental contact. For adjustment, the following steps apply:

- Loosen the shaft by rotating the outer locking nut counter-clockwise with a 7/16-inch wrench.
- Adjust the shaft with a flat screwdriver to the desired output level.
- Tighten the outer locking nut, rotating clockwise, to approximately 5 LB-in (0.56 N-m).

**NOTE:** Take care not to over-torque the outer nut. Should the cone nut become loose or jammed with the outer locking nut, re-torque the cone nut with a 1/2-inch wrench to approximately 15 LB-in (1.69 N-m).

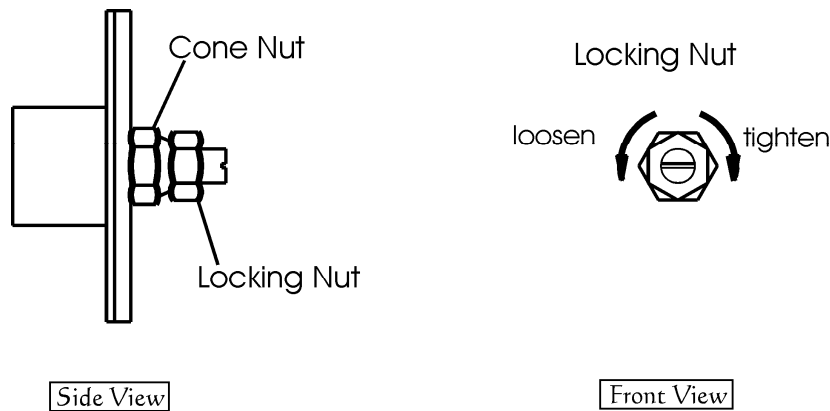

**Figure 3-7. Shaft Lock**



**CAUTION!**

Never fully loosen the cone nut, or remove the shaft lock from the chassis.

### 3.3 LOCAL OPERATION

The SGA Series power supply is shipped from the factory configured for local voltage/current control and local voltage sensing. The ANALOG CONTROL connector is supplied with a mating connector with remote output ON/OFF jumpered for ON (terminal 5 shorted to terminal 6).

**WARNING!**

The power-up factory default state is output enabled.

1. Prior to turning the unit on, rotate the voltage and current potentiometers fully counterclockwise (minimum output).
2. Turn the power ON and adjust the voltage and current to the desired output.

#### 3.3.1 FLOATING AND POLARIZED OUTPUT

The SGA Series supply can be set up for a Positive or Negative supply, as well as standard operation as a floating output supply.

**FLOATING OUTPUT**

The output terminals are normally floating from chassis ground. No extra steps or connections are required for a floating output.

**POSITIVE SUPPLY SETUP**

Attach the negative output terminal to the supply chassis. The output reference is now chassis ground. When the output voltage is set or programmed, the supply will output a positive potential from chassis ground.

**NEGATIVE SUPPLY SETUP**

Attach the Positive output terminal to the supply chassis. The output reference is now chassis ground. When the output voltage is set or programmed, the supply will output a negative potential from chassis ground.

**CAUTION!**

Floating the negative output terminal floats the power supply's internal control circuitry common level to the same potential as the negative output terminal. On a standard non-isolated supply the common of the analog control connector (J1) floats at the same potential as the negative output terminal. Damage may occur if the non-isolated analog control connector of a supply is connected to an external ground referenced input/output device. Such a connection creates ground loop currents. To correct ground loop problems the Isolated Analog option is advised in order to isolate the external ground reference signals from the internal control circuitry of the supply.

### 3.3.2 INITIAL SETUP

1. Before connecting the unit to an AC outlet, ensure that the front panel ON/OFF power switch is in the OFF position.
2. Ensure that the Voltage and Current control knobs are fully counterclockwise.
3. Check the ANALOG CONTROL (J1) mating connector on the rear panel to verify that pins 5 and 6 (Remote Output On/Off) are shorted together to enable the output of the supply (see Section 3.7). This is the default configuration installed from the factory.
4. Apply power to the AC mains input.

### 3.3.3 VOLTAGE MODE OPERATION

When the supply is in the Voltage mode, the output voltage of the supply is controlled by the Voltage knob on the front panel or by the remote voltage input. See Section 3.5. The Current knob (or remote current input) operates as a current limit. The output voltage is regulated at the selected value while the output current varies with the load requirements. To verify operation in Voltage mode, follow the steps below:

1. Connect a digital voltmeter (DVM) across the rear panel positive and negative output terminals, observing the correct polarity. Make sure the DVM is in the dc voltage mode and the range is adequate to handle the full-scale voltage of the power supply.
2. Rotate the Current control knob about  $\frac{1}{2}$  turn clockwise (this sets the current limit at a nominal setting above 0 Amps)
3. Switch the power supply on.
4. Slowly rotate the Voltage knob clockwise and observe both the front panel voltage display and the output of the DVM. The minimum range should be from 0V to the maximum rated voltage output of the supply. The front panel display and DVM readings should track within the accuracies of the meter and the front panel display.
5. Check that the green Voltage Mode LED is on.
6. Turn the Voltage knob and Current knob fully counterclockwise.
7. Switch the power supply off.

If Voltage mode operation did not function as indicated above, recheck your setup and perform the check again. If the function continues to fail, contact the factory for assistance.

### 3.3.4 CURRENT MODE OPERATION

When the supply is in the Current Mode, the output current of the supply is controlled by the Current knob on the front panel or by the remote current input (see Section 3.4). The Voltage control knob (or remote voltage input) operates as a voltage limit. To verify operation in current mode, follow the steps below:

1. Connect a high current DC ammeter across the rear panel positive and negative output terminals, observing the correct polarity.
2. Select wire leads of sufficient current carrying capacity and an ammeter range compatible with the unit's maximum rated output current.  
**Note:** If a high current ammeter is not available, you may simply short the output terminals together. This will not harm the supply.
3. Rotate the Voltage control knob about  $\frac{1}{2}$  turn clockwise (this sets the Voltage limit at a nominal setting above 0 Volts and forces the supply into current mode).
4. Switch the power supply on.
5. Slowly rotate the Current knob clockwise and observe both the front panel current display and the output of the ammeter. The minimum range should be from 0A to the maximum rated current output of the supply. The front panel display and ammeter readings should track within the accuracies of the meter and the front panel display.
6. Check that the green Current Mode LED is on.
7. Turn the Voltage knob and Current knob fully counterclockwise.
8. Switch the power supply off.
9. Disconnect the ammeter or short from the output terminals.

If Current Mode operation did not function as indicated above, recheck your setup and perform the check again. If the function continues to fail, contact the factory for assistance.

### 3.3.5 OVERVOLTAGE PROTECTION

The Overvoltage Protection (OVP) function allows the supply to shutdown the output when it exceeds a preset voltage. This may be used to protect sensitive circuits or loads from damage caused by an excessive voltage on the output of the supply.

To verify OVP operation:

1. Make sure there is nothing connected across the output terminals.
2. Rotate the Current control knob about  $\frac{1}{2}$  turn clockwise (this sets the current limit at a nominal setting above 0 Amps)
3. Switch the power supply on.
4. Press and hold the Set/Reset Overvoltage Protection pushbutton on the front panel and observe the reading on the voltage display. This is the present setting of the OVP limit. The factory default setting is approximately 110% of the maximum rated output of the supply.
5. While holding down the Set/Reset button, use a small adjustment screwdriver to adjust the OVP setting by turning the 4-turn recessed adjustment potentiometer counterclockwise. As you adjust the potentiometer the reading on the voltage display should decrease (increase as you adjust in a clockwise direction).
6. Set the OVP to about 80-90% of the maximum rated output voltage and note the OVP voltage value.
7. Release the Set/Reset pushbutton.
8. Rotate the Voltage knob clockwise until the voltage display indicates you are about 2-3% below the OVP voltage value noted above.
9. Slowly continue to increase the output of the supply until you exceed the value of the OVP setting.
10. Check that the OVP LED lights and that the output of the supply powers down to 0 volts (as indicated on the Voltage display).
11. Turn the Voltage knob fully counterclockwise, then press and hold the Set/Reset pushbutton until the OVP LED is no longer lit.
12. Reset the OVP setting as appropriate for your application per steps 4 and 5 above. If you do not choose to use OVP, then the OVP adjust may be set fully clockwise to approximately 110% of the rated output voltage of the supply.

If OVP mode did not function as indicated above, recheck your setup and perform the check again. If the function continues to fail, contact the factory for assistance.

### 3.3.6 ANALOG CONTROL CONNECTOR (J1)

The ANALOG CONTROL connector on the rear panel allows the unit to be configured for different operating configurations: local and remote current programming, local and remote voltage programming, current and voltage output monitoring, output enable/disable, etc. The setup and operating requirements of each configuration are provided in Sections 3.4 through 3.9.

#### ISOLATED ANALOG CONTROL (OPTION)

The Isolated Analog Control uses the same Analog Control connector (J1). This option fully isolates remote control signals and allows control of units not connected to a common ground. Control ground is isolated from power ground, which protects against potential damage from systems with high electrical noise or large ground loop currents.

**Note:** Some standard analog programming signals may not be available with this option. See Table 1.2.2 for details.



#### CAUTION!

This option is not intended to allow operation of the power supply at excessive voltages. Refer to Section 2 INSTALLATION for maximum terminal voltages.

Following are Figure 3-8 with the connector's pin-out diagram, and Table 3-1 with ANALOG CONTROL connector designations and functions:

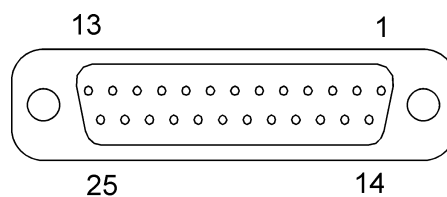

**Figure 3-8. ANALOG CONTROL Connector (J1) Pin-out**

Designator	Schematic Symbol	Electrical Chars.	Functional Description
1	ISO ON/OFF	$Z_{in} \sim 6 \text{ k}\Omega$	Isolated remote output on/off. Externally supplied AC/DC voltage source for on/off control. A positive (+) 12 to 240 VAC or 6 to 120 VDC voltage will enable the output, i.e., turn on the output of the supply. This input control is optically isolated from the power supply circuit up to 500 VDC. Circuit return Pin 2 (ISO RTN). See Section 3.7.
2	ISO RTN	—	Isolated circuit return used with isolated on/off control J1-1 and J1-14.
3	REM OV SET	$Z_{in} \sim 20 \text{ k}\Omega$	Remote overvoltage set. A remote signal sets the overvoltage trip level. 0.25-5.5 VDC = 5-110%. Apply a 10.5 VDC to 13.3 VDC signal for 7 seconds to reset an OVP condition. Circuit return Pin 6 (COM). See Section 3.8.
4	VP RTN	$Z_{in} \sim 10 \text{ k}\Omega$	Voltage programming return. Used with J1-9, J1-15 or J1-21 and must be referenced to Pin 6 (COM) circuit common.
5	ON/OFF	Must sink ~1mA to enable	Remote output on/off. Switch/relay contacts or a direct short between this terminal and Pin 6 (COM) circuit common, enables the output, i.e., turns on the output of the supply. See Section 3.7.
6	COM †	-	Circuit common. Electrically equal to Pin 24. Same potential as the negative output terminal.
7	I MON	$Z_{out} \sim 100\Omega$	Output current monitor. 0-10 VDC equals 0-100% rated current. Minimum load resistance 10k $\Omega$ . Circuit return Pin 6 (COM).
8	V SET *	$Z_{out} \sim 100\Omega$	0-5 VDC (0-100%) front panel voltage potentiometer set point monitor output. Minimum load resistance 10k $\Omega$ . Circuit return Pin 6 (COM).
9	VP 5V	$Z_{in} \sim 10\text{k}\Omega$	Remote voltage programming using a 0-5 VDC source. Do not exceed 13.3 VDC. Circuit return Pin 4 or Pin 20 (VP RTN). See Section 3.5.
10	IP 5V	$Z_{in} \sim 10\text{k}\Omega$	Remote current programming using a 0-5 VDC source. Do not exceed 13.3 VDC. Circuit return Pin 23 or Pin 25 (IP RTN). See Section 3.4.

Designator	Schematic Symbol	Electrical Chars.	Functional Description
11	ISET *	Zout ~ 100Ω	0-5 VDC (0-100%) front panel current potentiometer set point monitor output. Minimum load resistance 10kΩ. Circuit return Pin 6 (COM).
12	Not Used		
13			
14	ISO TTL/CMOS	Zin ~ 2.2kΩ	Isolated TTL/CMOS on/off control. A high state TTL/CMOS voltage enables the output, i.e., turns on the output of the supply, and a low state or open connection disables the output, i.e., turns off the output of the supply.. Circuit return Pin 2 (ISO RTN). See Section 3.7.
15	VP 10V	Zin ~ 20kΩ	Remote voltage programming using a 0-10 VDC source. Do not exceed 25 VDC. Circuit return Pin 4 or Pin 20 (VP RTN). See Section 3.5.
16	IP 10V	Zin ~ 20kΩ	Remote current programming using a 0-10 VDC source. Do not exceed 25 VDC. Circuit return Pin 23 or Pin 25 (IP RTN). See Section 3.4.
17	FAULT	Zout ~ 100Ω	Fault state output. A high state (approximately +10 VDC) indicates a converter, temperature or bias supply fault, and the LED on the front panel will illuminate. Circuit return Pin 6 (COM).
18	S/D FAULT	Zout ~ 100Ω	Shutdown fault. This terminal goes to high state in the event of converter, temperature, overvoltage or bias supply fault. A 7 VDC to 13.3 VDC signal can be applied to this pin to shutdown the output of the unit. An 8 VDC minimum output signal is provided into a 10 kΩ minimum load, in the event of an internally generated shutdown. Circuit return Pin 6 (COM). See Section 3.9.
19	V MON	Zout ~ 100Ω	Output voltage monitor. 0-10 VDC equals to 0-100% rated voltage. Minimum load resistance 10kΩ. Circuit return Pin 6 (COM).
20	VP RTN	Zin ~ 10Ω	Voltage programming return. Used with J1-9, J1-15 or J1-21 and must be referenced to Pin 6 (COM) circuit common.
21	VP RES *	~ 10.8V compliance	1 milliamp current source for remote voltage programming using resistance. 0-5k ohm resistor referenced to Pin 4 or Pin 20 (VP RTN) will program the output voltage from 0-100%. See Section 3.5.

Designator	Schematic Symbol	Electrical Chars.	Functional Description
22	IP RES <sup>*</sup>	~ 10.8V compliance	1 milliamp current source for remote current programming using resistance. 0-5k ohm resistor referenced to Circuit return Pin 23 or Pin 25 (IP RTN) will program the output current from 0-100%. See Section 3.4.
23	IP RTN	Zin ~ 10kΩ	Current programming return. Used with J1-10, J1-16 or J1-22 and must be referenced to Pin 6 (COM) circuit common.
24	COM <sup>†</sup>	-	Circuit common. Electrically equal to Pin 6. Same potential as the negative output terminal.
25	IP RTN	Zin ~ 10kΩ	Current programming return. Used with J1-10, J1-16 or J1-22 and must be referenced to Pin 6 (COM) circuit common.

**Table 3–1. ANALOG CONTROL Connector (J1), Designations and Functions**

<sup>†</sup> Control ground is isolated from power ground with the isolated analog control (option). See Section 3.3.1

<sup>\*</sup> Signals not available with isolated analog control (option).



**CAUTION!**

If standard analog programming is used, note the programming return (J1-6 & J1-24) is at the same potential as the negative output terminal of the power supply. Observance of return connections should be made with respect to input programming signal equipment. Improper connection may result in ground loops and as a result internal power supply damage may occur. (Output current then flows to chassis by means of external connection to the J1 common (J1-6 & J1-24)).

### 3.4 REMOTE CURRENT PROGRAMMING

Remote current programming is used for applications that require the output current be programmed (controlled) from a remote source. An external resistance or external voltage source may be used as a programming device.

When using remote current programming, a shielded, twisted-pair, hookup wire is recommended to prevent noise interference with programming signals.

#### 3.4.1 REMOTE CURRENT PROGRAMMING USING RESISTANCE:

The resistance coefficient for remote current programming is 5k ohms/100% rated output with respect to terminal J1-23 (IP RTN). The programming current from terminal J1-22 (IP RES) is factory set for 1 milliampere. This yields a coefficient of 1.0% of rated output current for each 50 ohms. If multiple switches or relays are used to program different levels, make-before-break contacts are recommended.

**Note:** If an external resistance is used for remote programming, the current programming return (IP RTN), terminal J1-23, must be connected directly to or within  $\pm 3$  volts of the power supply common terminal, J1-24. See Figure 3-9 for connection requirements.

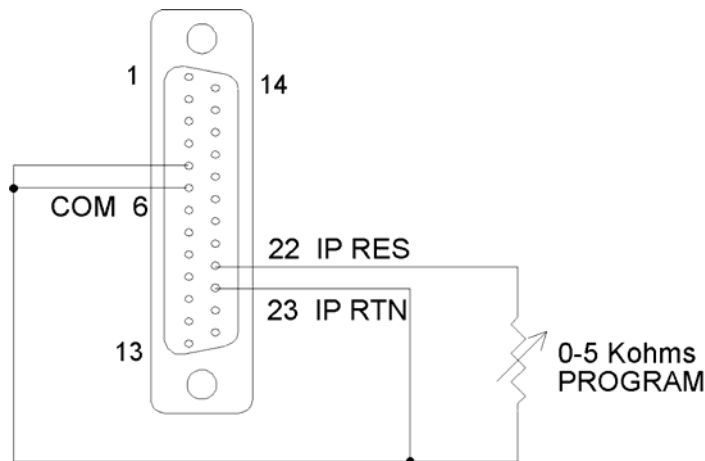

**Figure 3-9. Remote Current Programming Using Resistance**

### 3.4.2 REMOTE CURRENT PROGRAMMING USING A 0-5 OR 0-10 VDC VOLTAGE SOURCE

A DC voltage source for remote current programming is connected between J1-10 (IP 5V) or J1-16 (IP 10V) and the return terminal J1-23 (IP RTN).

**Note:** The return terminal J1-23 (IP RTN) must be referenced directly to or within  $\pm 3V$  of the power supply common, J1-24.

The voltage coefficient for 5V remote current programming is 50 millivolts = 1% of rated output, i.e., for a 300 amp model, each 50 millivolts of programming voltage equals 3 amps of output current.

The voltage coefficient for 10V remote current programming is 100 millivolts = 1% of rated output, i.e., for a 300 amp model, each 100 millivolts of programming voltage equals 3 amps of output current. See Figure 3-10 for connection requirements.

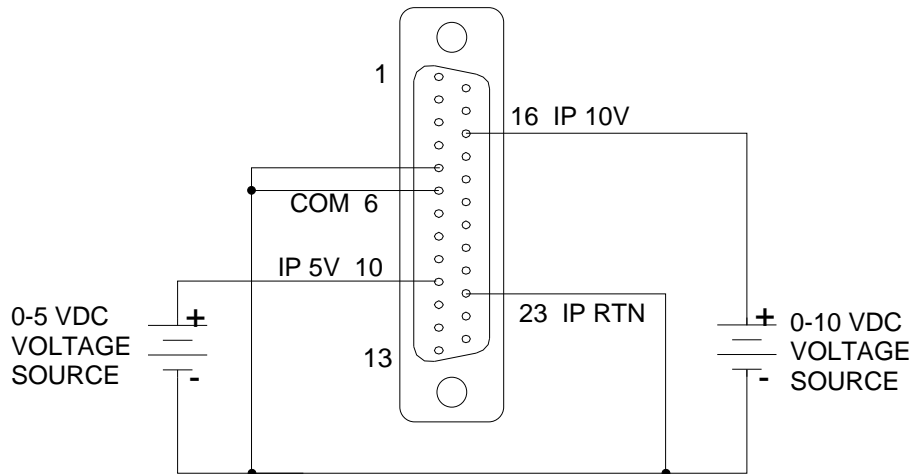

**Figure 3-10. Remote Current Programming Using 0-5 or 0-10 VDC Voltage Source**

## 3.5 REMOTE VOLTAGE PROGRAMMING

Remote voltage programming configuration is used for applications that require the output voltage be programmed (controlled) from a remote source. An external resistance or external voltage source may be used as a programming device. When using remote voltage programming, a shielded, twisted-pair, hookup wire is recommended to prevent noise interference with programming signals.

### 3.5.1 EXTERNAL VOLTAGE PROGRAMMING USING RESISTANCE

The resistance coefficient for remote voltage programming is 5k ohms/100% of rated output voltage with respect to the VP RTN, J1-20. The programming current from terminal J1-21 (VP-RES) is factory set to 1 milliampere. This yields a coefficient of 1.0% of rated output voltage for each 50 ohms. If multiple switches or relays are used to program different levels, make-before-break contacts are recommended.

**Note:** If an external resistance is used for remote programming, the voltage programming return (VP RTN), terminal J1-20, must be connected directly to or within  $\pm 3$  volts (see note) of the power supply common terminal, J1-24. See Figure 3-11 for connection requirements.

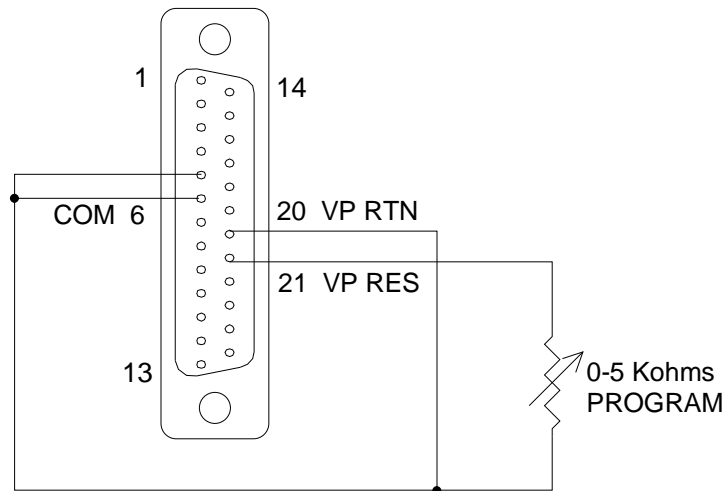

**Figure 3-11. Remote Voltage Programming Using Resistance**

### 3.5.2 EXTERNAL VOLTAGE PROGRAMMING USING A 0-5 OR 0-10 VDC VOLTAGE SOURCE

A DC voltage source for remote voltage programming is connected between J1-9 (VP 5V) or J1-15 (VP 10V) and the return terminal J1-20 (VP RTN).

**Note:** The return terminal (VP RTN) must be referenced directly to or within  $\pm 3V$  of the power supply common, J1-24.

The voltage coefficient for 5V remote voltage programming is 5 volts = 100% of rated output voltage.

The voltage coefficient for 10V remote voltage programming is 10 volts = 100% of rated output voltage. See Figure 3-12 for connection requirements.

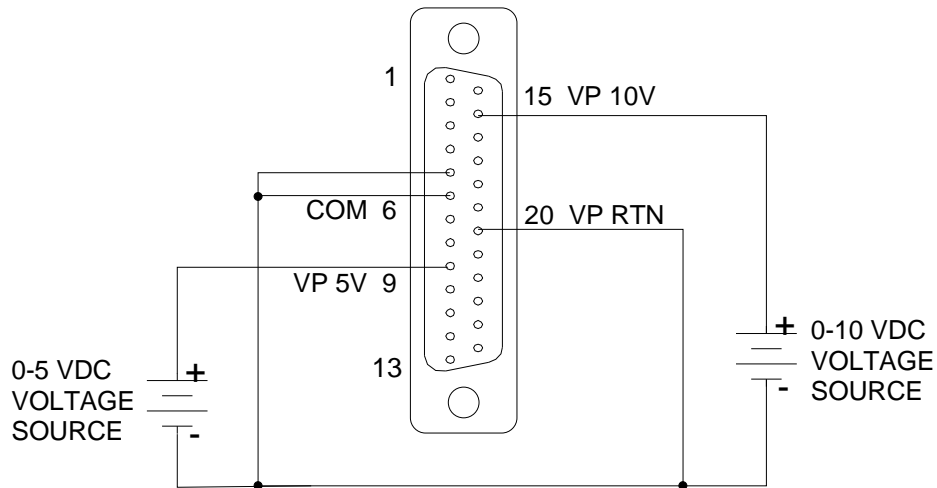

**Figure 3-12. Remote Voltage Programming Using 0-5 or 0-10 VDC Voltage Source**

### 3.6 REMOTE SENSING

Remote voltage sensing is recommended at all times, whether you connect sensing leads to the load or directly to the output terminals. Remote sensing at the load provides the best load regulation.

In applications where the load is located some distance from the power supply, or the voltage drop of the power output leads significantly interferes with load regulation, remote voltage sensing should definitely be used.

The voltage accuracy specifications are valid only with remote sense connected. Disconnecting the remote sense leads will introduce an error, with the output voltage increasing. The error occurs because an additional resistance (PTC local resistor network in Figure 3-13) is added in the circuit of the resistor divider for voltage sensing, to provide the default local sensing of the output voltage at the output terminals. When remote sense is connected the PTC local resistor network is short-circuited, effectively removing it from the circuit.

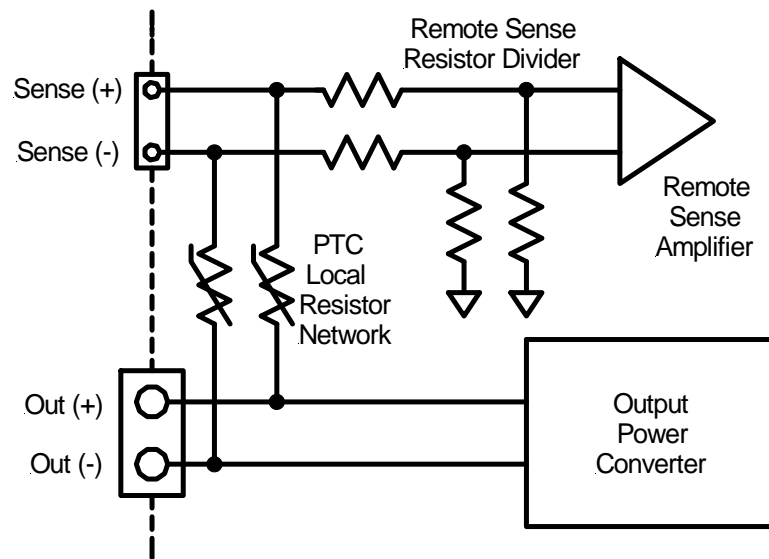

**Figure 3-13. Local/Remote Voltage Sensing**



**CAUTION!**

If the power supply is operated with load power lines disconnected and sensing line connected, internal power supply damage may occur. (Output current then flows through sensing terminals.)

To use remote voltage sensing, connect the power supply as described below. See Figure 3-14 for connection requirements.

Connect sensing leads from the load positive to J3-1 and the load negative to J3-2 (load negative to J3-3 on 800V models). A shielded, twisted-pair, hookup wire is recommended to avoid potential noise interference.

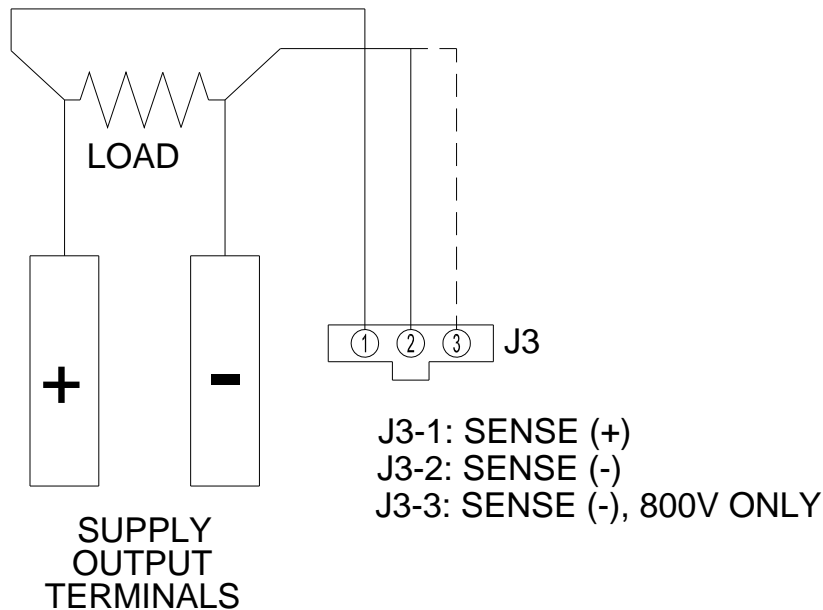

**Figure 3-14. Remote Sensing Operation at the Load**

### 3.7 REMOTE OUTPUT ON/OFF CONTROL

Remote output on/off control may be accomplished by contact closure or by an isolated external AC/DC or TTL/CMOS voltage source.

#### 3.7.1 REMOTE OUTPUT ON/OFF BY CONTACT CLOSURE

Output is on when contacts (J1-5 and J1-6) are closed. See Figure 3-15 for connection requirements.

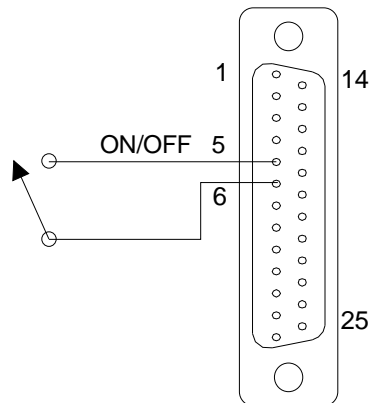

**Figure 3-15. Remote Output ON/OFF Control by Contact Closure**

#### 3.7.2 REMOTE OUTPUT ON/OFF CONTROL BY AN EXTERNAL 12 TO 240 VAC OR 6 TO 120 VDC OR TTL/CMOS SOURCE

Application of AC/DC or high state TTL/CMOS voltage will turn on the power supply. See Figure 3-16 and Figure 3-17 for connection requirements.

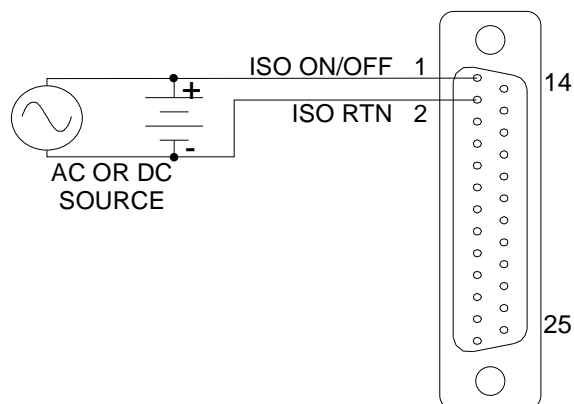

**Figure 3-16. Remote Output ON/OFF Using Isolated AC or DC Voltage Source**

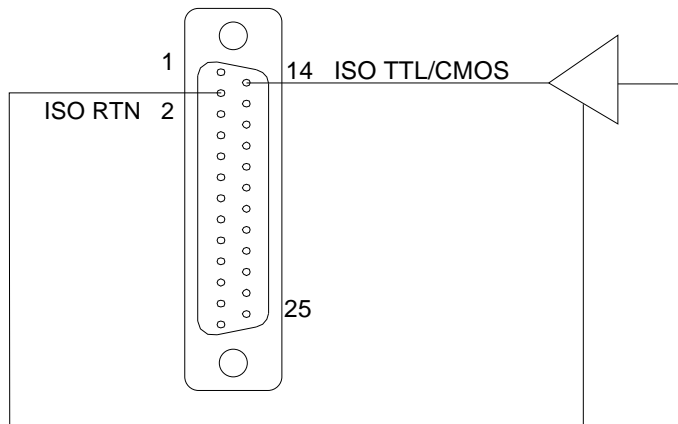

**Figure 3-17. Remote Output ON/OFF Using Isolated TTL/CMOS Voltage Supply**

### 3.8 REMOTE OVERVOLTAGE SETPOINT



**CAUTION!**

Do not program the remote overvoltage set point greater than 10% (5.5V) above the power supply rated voltage (except as noted) as internal power supply damage may occur.

A remote DC voltage source can be connected externally between terminals J1-6 (COM) and J1-3 (REM OV SET) to set the output overvoltage trip level. A 0.25-5.5 VDC signal equals 5-110% of rated output voltage. See Figure 3-18 for connection requirements.

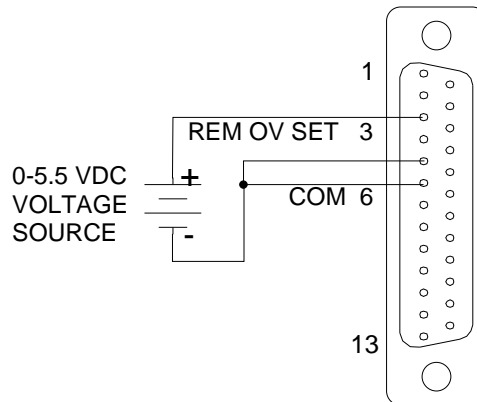
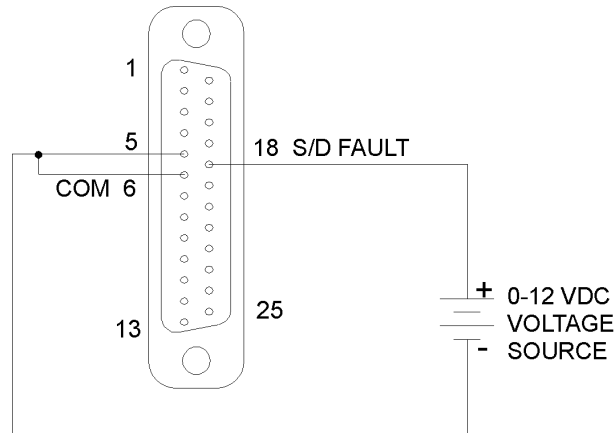

**Figure 3-18. Remote Overvoltage Set Using DC Voltage Source**

**Note:** The Remote OVP trip level will ALWAYS take precedence over the local trip level, even if the local OVP trip level is set to a lower value. To reset an OVP externally, apply a 10.5–13.3 VDC signal to J1-3 for a minimum of four (4) seconds.

### 3.9 REMOTE SHUTDOWN (S/D)

A remote +12 VDC voltage can be connected externally between terminals J1-18 (S/D Fault) and J1-24 (COM) to disable, i.e., shut down the output of the power supply (Figure 3-19). Disabling or opening the +12 VDC signal will allow the unit to revert to normal operation.



**Figure 3-19. Remote Shutdown Using DC Voltage Source**

## 3.10 PARALLEL AND SERIES OPERATION

The following modes of operation are used for applications requiring more current or voltage than is available from a single power supply. To meet the requirements for greater output voltage or current, two supplies may be connected in series or up to five connected in parallel.

### 3.10.1 PARALLEL OPERATION

In order to connect up to five power supplies in parallel, use a "Master/Slave" daisy-chain wiring configuration as follows (refer to Figure 3-20):

(Note that there are two separate 9-pin connectors on the upper left rear panel of each power supply, marked "PAR OUT" and "PAR IN").

1. Beginning with the power supply designated (by you) as the Master power supply, use an interface cable (P/N 890-453-03) to connect the PAR OUT connector on the designated Master power supply to the PAR IN connector on the second power supply (Slave 1).
2. On the second power supply (Slave 1), use another interface cable to connect the PAR OUT connector to the third power supply's (Slave 2) PAR IN connector. Continue these interconnections up to a maximum of 5 power supplies.
3. Connect the Positive output terminals of all the power supplies and the Load.
4. Connect the Negative output terminals of all the power supplies and the load.
5. Confirm that there are no shorts between the Positive and Negative output terminals.
6. Referring to Figure 3-20, connect twisted pair cables as follows:

All slave units shall have twisted pairs from their SENSE terminals to their output terminals, as appropriate.

For **Remote** Sense, the master unit shall have a twisted pair from its own SENSE terminals to the Load's output terminals.

For **Local** Sense, the master unit shall have a twisted pair from its own SENSE terminals to its own output terminals.

Ensure that all twisted pair cables are as short as possible.

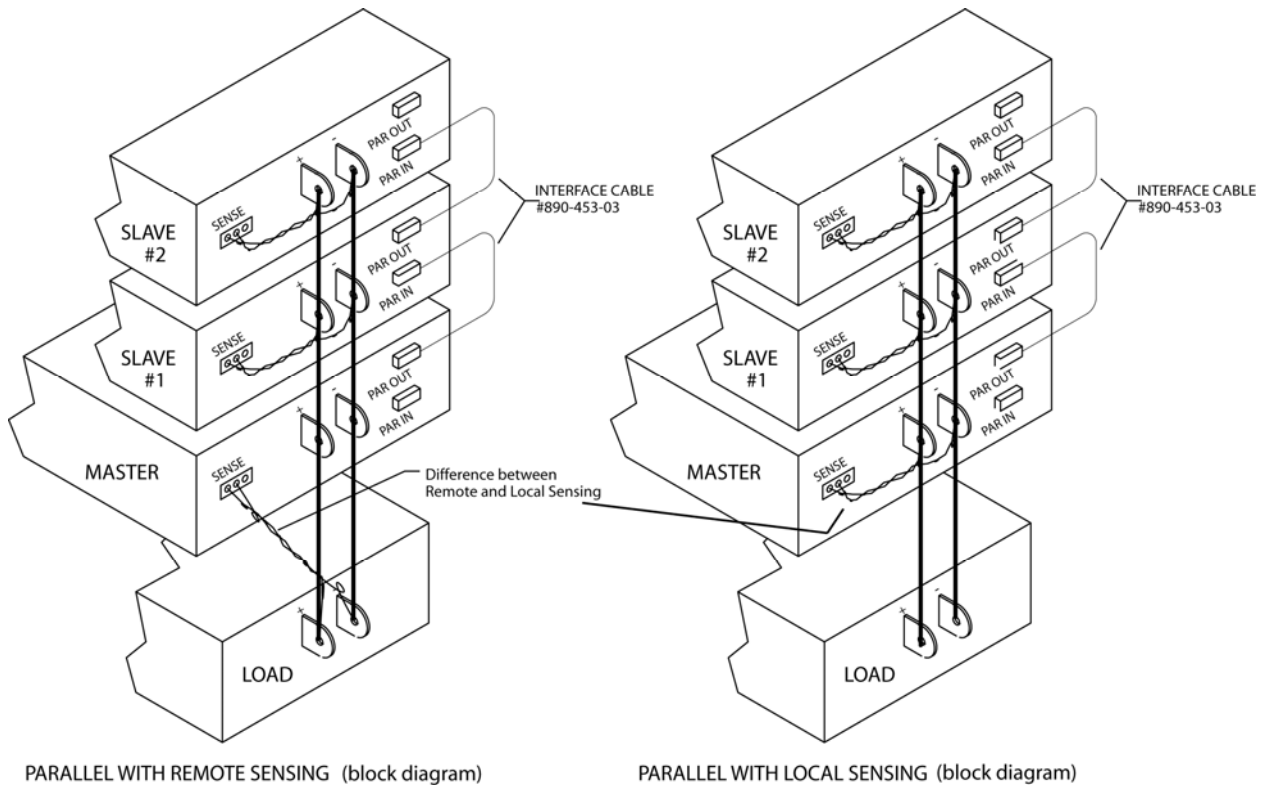

**Figure 3-20. Parallel and Remote/Local Sense Connections**

**Note:** The OVP circuit remains active for all units in parallel operation. If the units are set to different OVP levels, the paralleled system will trip according to the lowest setting. For ease of use, adjust the OVP levels for the slaves to maximum and adjust the master OVP level to the desired setting.

### 3.10.2 SERIES OPERATION

Series operation is used to obtain a higher voltage single output supply using two units. To set up series operation:

Connect the negative terminal (–) of one supply to the positive terminal (+) of the next supply of the same model. The total voltage available is the sum of the maximum voltages of each supply (add voltmeter readings).

**Notes:**

- Under no condition should the negative (–) output terminal of any power supply exceed 300V to Earth ground. This is limited by the creepage/clearance distances internal to the construction. If a

higher output voltage range is required, contact the Sales Department or Customer Service for availability.

- The maximum allowable current for a series string of power supplies is the rated output current of a single supply in the string.
- Remote sensing should **not** be used during series operation.
- A free-wheeling diode (power diode capable of the maximum current of the series set connected in parallel, but reverse biased) is recommended to protect against sinking current into a supply should one supply be "ON" while the other is "OFF." (See Section 2.6.1).

This page intentionally left blank.



## SECTION 4 MAINTENANCE

### 4.1 INTRODUCTION

This chapter contains preventive maintenance information for the SGA Series power supplies.



#### WARNING!

All maintenance that requires removal of the cover of the unit should only be done by properly trained and qualified personnel. Hazardous voltages exist inside the unit. Disconnect the supply from the input power before performing any maintenance. Service, fuse verification, and connection of wiring to the chassis must be accomplished at least *five minutes* after power has been removed via external means; all circuits and/or terminals to be touched must be safety grounded to the chassis.

### 4.2 PREVENTIVE MAINTENANCE

No routine maintenance on the SGA Series is required, aside from periodic cleaning of the unit when needed:

- Once a unit is removed from service, vacuum all air vents, including the front panel grill. Clean the exterior with a mild solution of detergent and water. Apply the solution onto a soft cloth, not directly to the surface of the unit. To prevent damage to materials, do not use aromatic hydrocarbons or chlorinated solvents for cleaning.
- Low-pressure compressed air may be used to remove dust from in and around components on the printed circuit boards.



#### WARNING!

The OFF position of the power switch does not remove voltage from the input terminal blocks. Remove all external power before performing any service.

An annual inspection of the SGA Series unit is recommended. Table 4–1 lists the visual inspection checks to be performed, and the corrective action to be taken.

**Table 4–1. Recommended Annual Inspection**

Item	Inspect For	Corrective Action
External connector plugs and jacks	Looseness, bent or corroded contacts, damage or improper seating in mating connector	Clean contacts with solvent moistened cloth, soft bristle brush, small vacuum, or low compressed air.
		Replace connectors damaged, deeply corroded, or improperly seated in mating connector.
Chassis, fan, and extruded heatsinks	Dirt and corrosion	Clean with cloth moistened with soapy water.
External electrical wiring	Broken, burned or pinched wire; frayed, worn or missing insulation	Repair or replace defective wires.
External solder connections	Corrosion, loose, cracked, or dirty connections	Clean and resolder connections.
Dirt and moisture buildup	Short circuits, arcing, corrosion, overheating	Clean as required.
Front panel controls and meters	Dirt and corrosion	Clean with cloth moistened with soapy water.
		Use a Kimwipe tissue and GTC glass–cleaning compound to clean the meter faces.



**CAUTION!**

For safe and continued operation of the SGA Series, always operate the unit in a temperature and humidity controlled, indoor area, free of conductive contaminants. Remember to keep the rear and sides of the unit free of obstructions to ensure proper ventilation.

## 4.3 FUSES

There are no user replaceable components in the power supply.



**WARNING!**

Only properly trained and qualified personnel should remove the cover from the power supply. Service, fuse verification, and connection of wiring to the chassis must be accomplished at least *five minutes* after power has been removed via external means; all circuits and/or terminals to be touched must be safety grounded to the chassis.



**CAUTION!**

To reduce the risk of fire or electrical shock, replace fuses only with the same type and rating.

This page intentionally left blank.

# INDEX

C

- Circuit Breaker Requirements, 1-4, 1-5
- Controls and Indicators, 3-1
  - Analog Control (J1), 3-14
- Current Mode
  - Operation, 3-12

F

- Fuses, 4-3

I

- Inductive Loads, 1-9
- Input/Output Connections, 1-3
  - Connector Functions, 1-4
- Isolated Analog Control, 3-14

J

- J1 Connector, 3-14

L

- Loads
  - Inductive, 1-9
- Location and Mounting, 1-2

M

- Maintenance
  - Annual Inspection, 4-2
  - Fuses, 4-3
  - Preventive, 4-1
- Master/Slave Operation, 3-27
- Mounting Hardware, 1-3

N

- Noise, 1-4, 1-5

O

- Operation
  - Current Mode, 3-12
    - Local, 3-10
    - Master/Slave, 3-27
    - Parallel, 3-27
    - Remote Current Programming, 3-18
    - Remote Output On/Off Control, 3-24
    - Remote Overvoltage Setpoint, 3-25
    - Remote Sensing, 3-22
    - Remote Shutdown, 3-26
    - Remote Voltage Programming, 3-20
    - Series, 3-28
    - Voltage Mode, 3-11
  - Overvoltage Protection, 3-13
  - Ozone Precaution, 1-2

P

- Parallel Operation, 3-27

R

- Rack slides, 1-2
- Remote Current Programming, 3-18
- Remote Output On/Off Control, 3-24
- Remote Overvoltage Setpoint, 3-25
- Remote Sensing, 3-22
- Remote Shutdown, 3-26
- Remote Voltage Programming, 3-20
- Ripple, 1-4, 1-5

---

	S	
Series Operation, 3-28		Ripple, 1-4
Setup, 3-11		Voltage, 1-4
Shaft Lock, 3-9		
Specifications, 1-2		V
Current, 1-4		Ventilation, 1-2
Electrical Characteristics, 1-2		Voltage Mode
Environmental Characteristics, 1-2		Operation, 3-11
Noise, 1-4		
Physical Characteristics, 1-5		W
		Wire Size, 1-6